



Sistemas Complementarios



Sistemas
Complementarios



www.alcemar.com.ar

2 Índice de Perfiles

Detalle de Perfiles en Escala 1:1

- 6 Frente de Placard
- 7 Tabique Divisor - Línea Alcemar
- 8 Tabique Divisor - Línea Tradicional
- 9 Mampara de Baño - Línea 900
- 10 Baranda Modelo BBA
- 11 Baranda Clásica
- 12 Revestimientos para Puerta de Rebatir
- 13 Cortina Común
- 14 Cortina Regulable
- 15 Angulos Normalizados
- 16 Tubos Normalizados
- 18 Perfiles Varios: Aereadores,
Travesaño para Policarbonato, Adaptador para D.V.H.

- 19 Perfiles para Escuadras de Armado,"U" de Blindex,Paño Liso
- 20 Perfiles para Puerta Blindex
- 21 Perfiles de Techo

Detalle de Armado











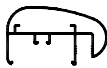





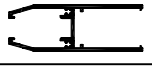



- 22 Perfiles de Techo - Línea Alcemar
- 23 Tabique Divisor - Línea Alcemar
- 26 Tabique Divisor - Línea Tradicional
- 27 Mampara de Baño - Línea 900
- 28 Baranda Modelo BBA
- 30 Baranda Clásica
- 31 Frente de Placard

Dimensiones de corte: Las medidas de corte contenidas en el presente catálogo son válidas únicamente para el armado de un prototipo, mediante el cual se deberá verificar el adecuado funcionamiento de todos los componentes a utilizar (Perfiles de Aluminio, Accesorios, Vidrios, etc.) antes de iniciar la producción en serie.

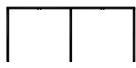
Peso de las Barras de Perfiles: El peso por metro de los perfiles es estimado, con una tolerancia de + / - 10%.

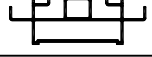



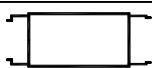















Largo de las Barras de Perfiles: La medida Standard de las Barras de Perfiles es de 6030 milímetros, salvo aclaración en contrario.

Alcemar S.A. se reserva el derecho de realizar cambios y/o modificaciones sin previo aviso de los artículos indicados en el presente Catálogo.

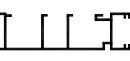
CODIGO	PESO (Kg/m)	T. x P.	DESCRIPCION	FORMA	PAG
28	1,35	2	Pasamano Curvo Baranda BBA		10
29	0,20	14	Tapa Inferior Pasamano Baranda BBA		10
30	0,83	4	Parante Baranda BBA		10
31	0,38	8	Porta Blisan Inferior Baranda BBA		10
55	0,56	4	Escuadra Universal Intermedia		19
86	1,00	3	Escuadra Suplementaria		19
97	0,64	5	Revestimiento Doble Faz		12
110	1,66	2	Zócalo Puerta Blindex		20
111	0,39	8	Suplemento Zócalo		20
124	0,64	6	Angulo de 100 x 20mm.		15
125	0,29	10	Angulo de 60 x 12mm.		15
155 (c)	0,53	6	Parante de 15 mm para Frente de Placard		6
156	0,16	20	Cantoneira de 15mm para Frente de Placard		6
157	0,25	8	Guía Inferior para Frente de Placard		6
158	0,20	20	Cantoneira de 18 mm para Frente de Placard		6
159 (c)	0,54	6	Parante de 18 mm para Frente de Placard		6
160	0,68	4	Guía Superior para Frente de Placard		6
191	1,19	3	Larguero de Techo		21
192	1,27	3	Travesaño de Techo		21
354	0,52	8	Marco Aereador con Mosquitero		18
355	0,55	6	Marco Aereador Aletado con Mosquitero		18
398	0,91	5	Revestimiento Tubular para Puerta de Rebatir		12
415	0,75	3	Revestimiento Tubular para Puerta de Rebatir		12

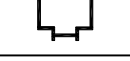

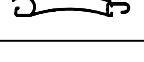
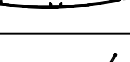
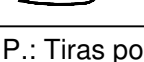



















Referencia (c): Largo de la Barra 5200 milímetros

T. x P.: Tiras por Paquete

CODIGO	PESO (Kg/m)	T. x P.	DESCRIPCION	FORMA	PAG
439	1,05	2	Pasamanos Recto para Baranda Clásica		11
457	0,90	3	Tubo Rectangular de 75 x 25 mm.		16
458	1,23	3	Tubo Rectangular de 90 x 40 mm.		16
464	1,12	2	Tubo Rectangular de 75 x 50 mm		16
468	0,53	8	Porta Vidrio para Baranda Clásica		11
475	1,30	2	Pasamanos Redondo para Baranda Clásica		11
476	0,61	8	Parante para Baranda Clásica		11
477	0,56	8	Base de Pasamanos para Baranda Clásica		11
490	0,67	4	Columna para Tabiquería Alcemar		7
491	0,40	8	Tapa Columna para Tabiquería Alcemar		7
492	0,54	8	Travesaño para Tabiquería Alcemar / Tradicional		7,8
493	0,48	8	Marco para Tabiquería Alcemar / Tradicional		7,8
494	0,19	12	Tapa Terminación para Tabiquería Alcemar		7
496	0,70	6	Columna para Tabiquería Tradicional		8
497	0,49	8	Tapa Columna para Tabiquería Tradicional		8
498	0,34	10	Tapa Zócalo para Tabiquería Alcemar / Tradicional		7,8
499	1,04	2	Zócalo para Tabiquería Alcemar / Tradicional		7,8
520	0,39	10	Travesaño para Policarbonato		18
553	0,21	16	Adaptador para D.V.H.		18
624 (a)	0,76	4	Zocalo Cortina Común		13
625 (a)	0,42	8	Tablilla Cortina Común		13
626	0,90	4	Zócalo para Cortina Regulable		14
627	0,49	6	Tablilla Comando para Cortina Regulable		14

Referencia (a): Largo de la Barra 6150 milímetros

T. x P.: Tiras por Paquete

CODIGO	PESO (Kg/m)	T. x P.	DESCRIPCION	FORMA	PAG
628	0,48	8	Tablilla Tubular para Cortina Regulable		14
650	0,25	16	"U" de Blindex		19
751	0,08	20	Angulo de 12,7 x 12,7 mm.		15
752	0,10	15	Angulo de 15 x 15 mm.		15
753	0,14	15	Angulo de 19 x 19 mm.		15
755	0,16	20	Angulo de 25,4 x 25,4 mm.		15
756	0,34	12	Angulo de 32 x 32 mm.		15
757	0,34	12	Angulo de 38 x 38 mm.		15
758	0,30	10	Angulo de 25 x 50 mm.		15
759	0,79	3	Angulo de 50 x 50 mm.		15
804	0,36	8	Tubo Cuadrado de 25 x 25 mm.		17
805	0,46	8	Tubo Rectangular de 40 x 20 mm.		17
806	0,40	8	Tubo Cuadrado de 30 x 30 mm.		17
807	0,63	6	Tubo Cuadrado de 38 x 38 mm.		17
808	0,71	6	Tubo Cuadrado de 45 x 45 mm.		17
809	0,55	6	Tubo Rectangular de 50 x 25 mm.		17
810	0,32	12	Tubo Rectangular de 30 x 12 mm.		17
811	0,79	6	Tubo Cuadrado de 50 x 50 mm.		17
812	0,63	6	Tubo Rectangular de 60 x 20 mm.		16
813	0,68	6	Tubo Rectangular de 60 x 30 mm.		16
830	0,16	10	Perfil "T" de 25 x 25 mm.		15
924	0,56	6	Marco Recto		19
941	0,82	4	Cabezal para Mampara de Baño 900		9

Referencia (a): Largo de la Barra 6150 milímetros

T. x P.: Tiras por Paquete

CODIGO	PESO (Kg/m)	T. x P.	DESCRIPCION	FORMA	PAG
942	0,37	8	Umbral para Mampara de Baño 900		9
943	0,32	8	Jamba para Mampara de Baño 900		9
944	0,35	10	Hoja para Mampara de Baño 900		9
946	0,24	20	Barra Toallera		9
970	2,00	2	Tubo Rectangular 110 x 54 mm.		16
995	0,31	10	Caño Redondo de 25,4mm.		17
996	0,47	7	Caño Redondo de 38,1mm.		17

Referencia (a): Largo de la Barra 6150 milímetros

T. x P.: Tiras por Paquete

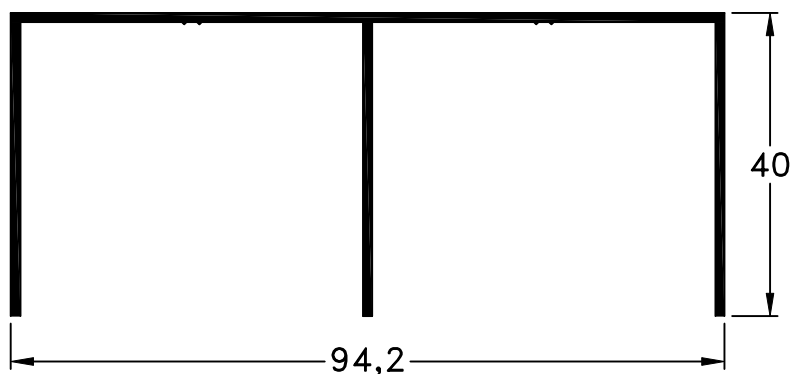

160 - Guía Superior
peso: 0,68 Kg/m

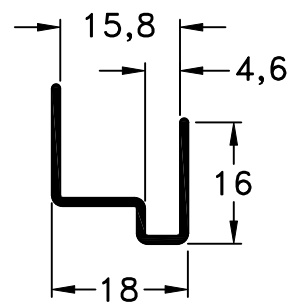

156 - Cantonera p/15mm
peso: 0,16 Kg/m

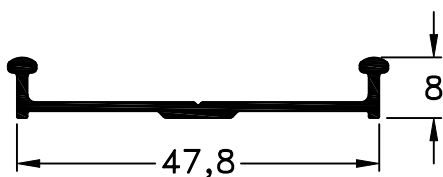

157 - Guía Inferior
peso: 0,25 Kg/m

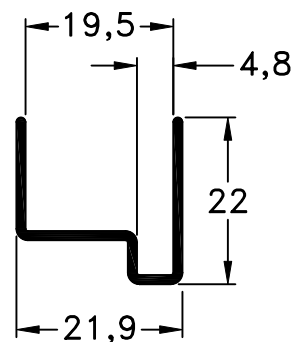

158 - Cantonera p/18 mm
peso: 0,20 Kg/m

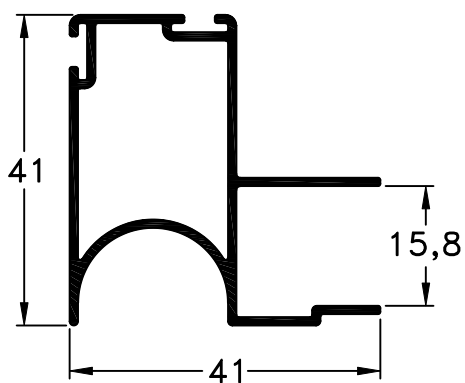

155 - Parante p/15 mm
Largo Std.: 5200 mm
Peso: 0,53 Kg/m

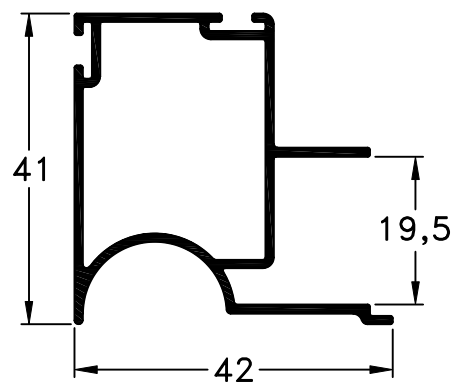

159 - Parante p/18mm
Largo Std.: 5200 mm
Peso: 0,54 Kg/m

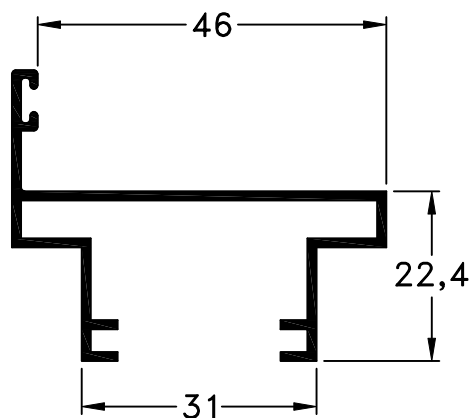

493 - Marco
peso: 0,48 Kg/m

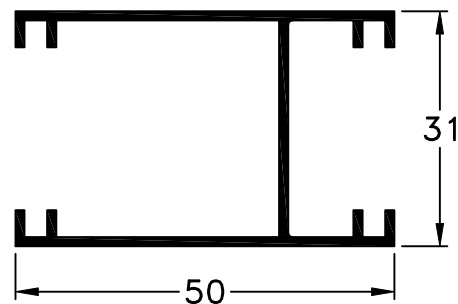

492 - Travesaño
peso: 0,54 Kg/m

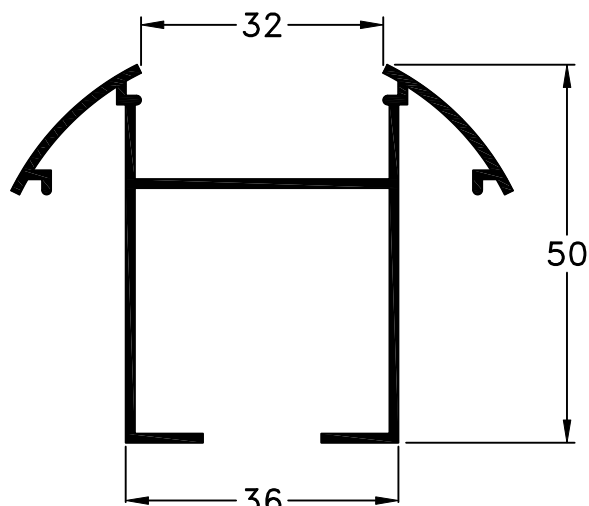

490 - Columna
peso: 0,67 Kg/m

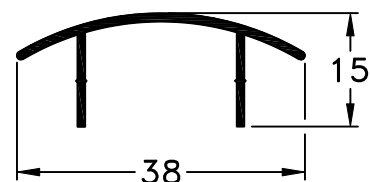

494 - Tapa
peso: 0,19 Kg/m

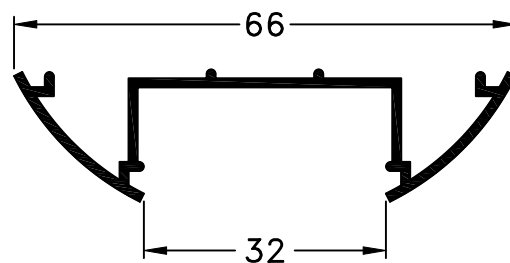

491 - Tapa Columna
peso: 0,40 Kg/m

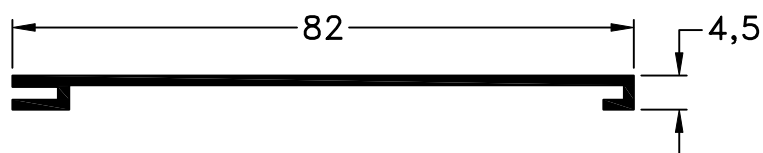

498 - Tapa Zócalo
peso: 0,35 Kg/m

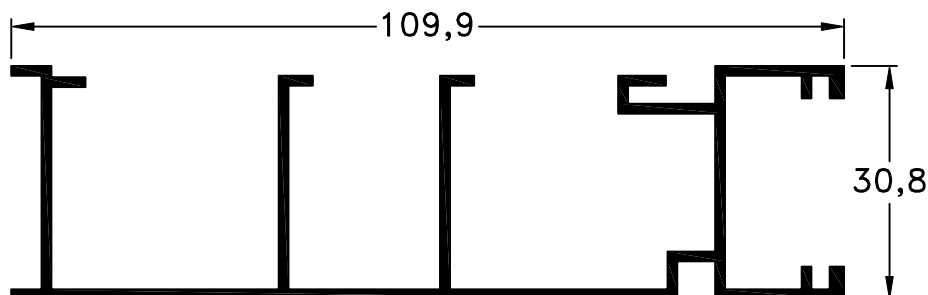

499 - Zócalo
peso: 1,20 Kg/m

Escala 1:1
Tolerancia en Peso +/- 10%

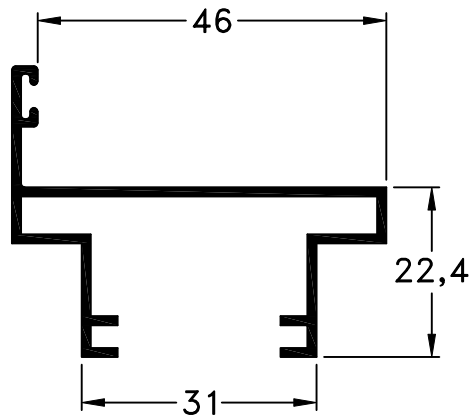

493 - Marco
peso: 0,48 Kg/m

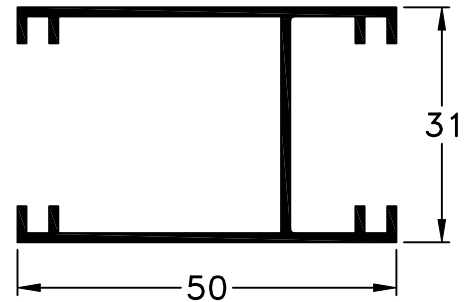

492 - Travesaño
peso: 0,54 Kg/m

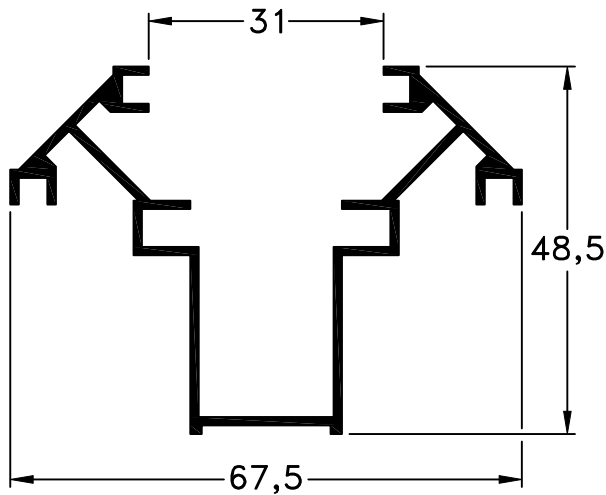

496 - Columna Tab.
peso: 0,70 Kg/m

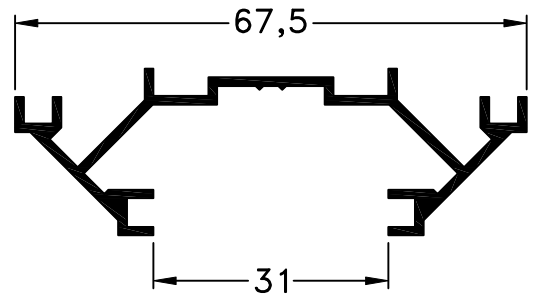

497 - Tapa Columna
peso: 0,49 Kg/m

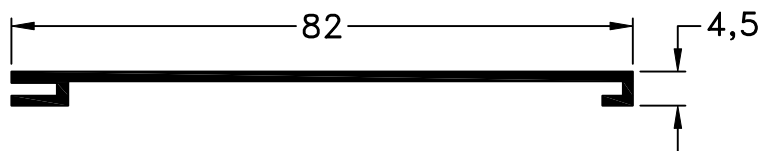

498 - Tapa Zócalo
peso: 0,34 Kg/m

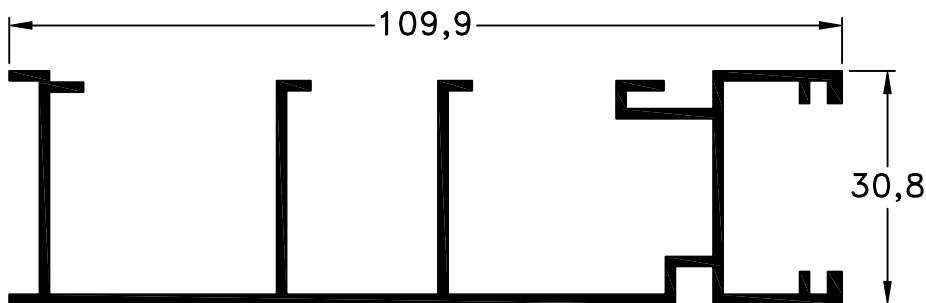

499 - Zócalo
peso: 1,04 Kg/m

Escala 1:1
Tolerancia en Peso +/- 10%

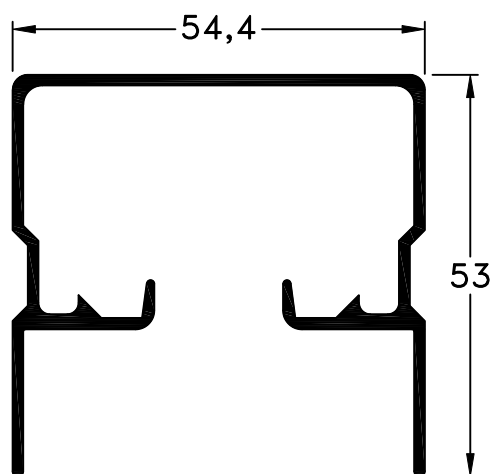

941 - Cabezal de Mampara
peso: 0,82 Kg/m

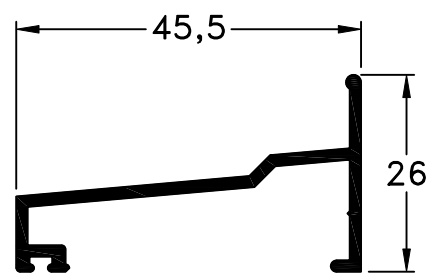

942 - Umbral de Mampara
peso: 0,37 Kg/m

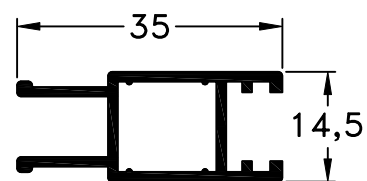

944 - Hoja de Mampara
peso: 0,35 Kg/m

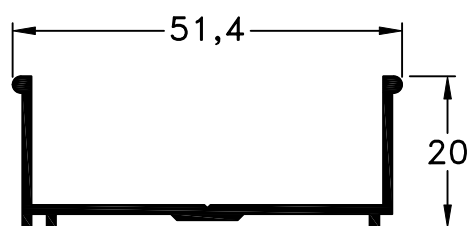

943 - Jamba de Mampara
peso: 0,32 Kg/m

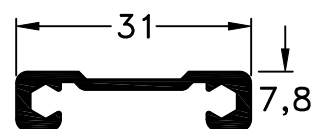

946 - Barra Toallera
peso: 0,24 Kg/m

Dimensiones de Corte					
Código	Forma	Función	Cant.	Largo	Corte
941		Cabezal	1	A	90° 90°
942		Umbral	1	A - 6	90° 90°
943		Jamba	2	H - 33.5	90° 90°
944		Hoja	4	A/2 + 11.5	45° 45°
944		Hoja	4	H - 68	45° 45°
946		Barra Toallera	1	Ancho de hoja - 55	90° 90°
-	-	Acrílico	2	A y H de hoja - 52	

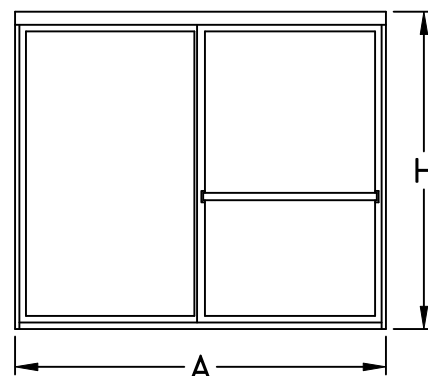

Escala 1:1

Tolerancia en Peso +/- 10%

20-01-12 **SISTEMAS COMPLEMENTARIOS.9**

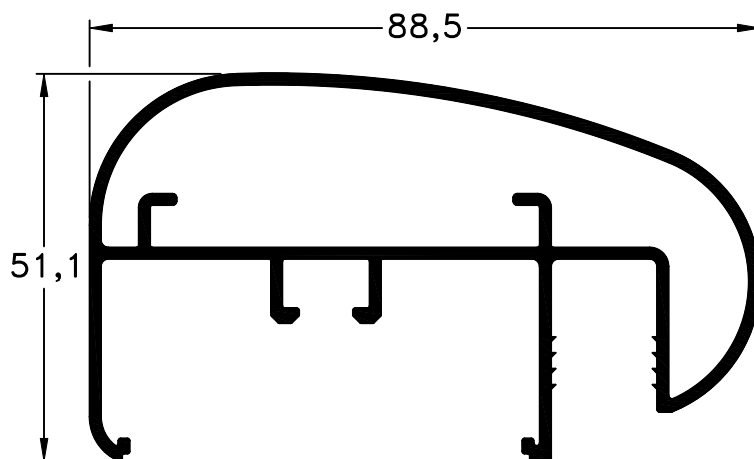

28 - Pasamano Curvo
Peso: 1,35 Kg/m

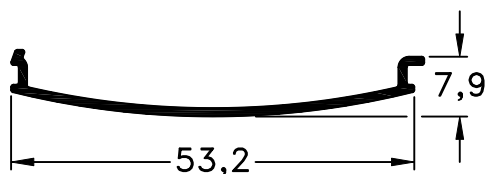

29 - Tapa Inferior Pasamano Curvo
Peso: 0,20 Kg/m

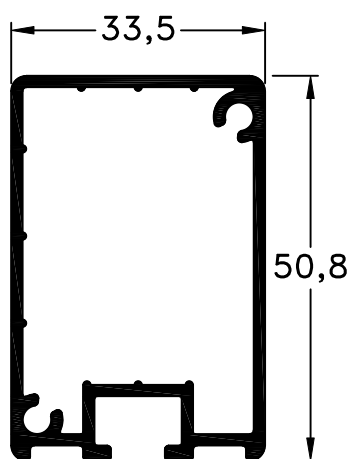

30 - Parante
Peso: 0,83 Kg/m

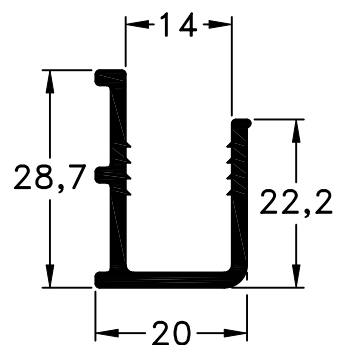

31 - Porta Blisan Inferior
Peso: 0,38 Kg/m

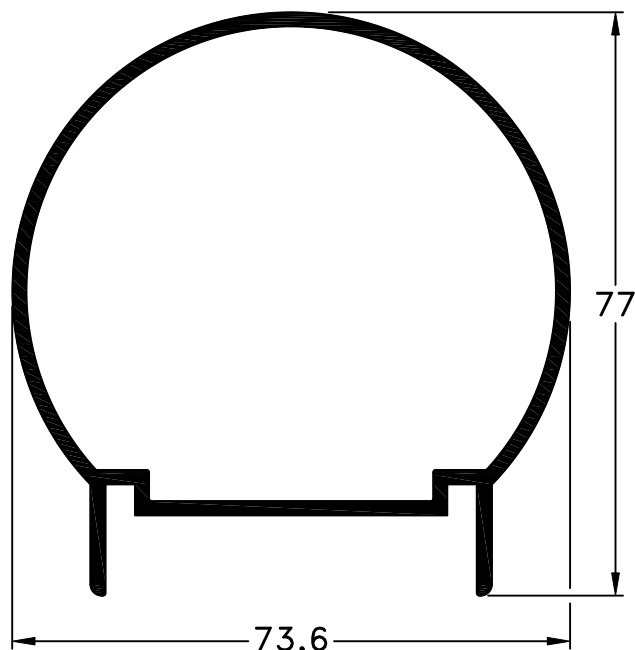

475 - Pasamanos
peso: 1,30 Kg/m

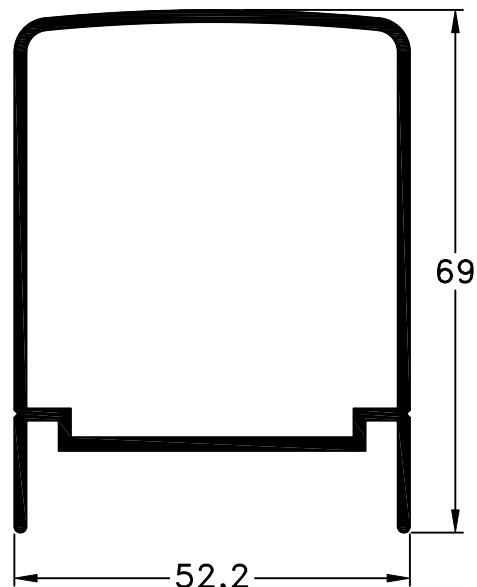

439 - Pasamanos
peso: 1,05 Kg/m

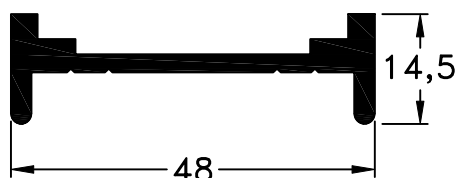

477 - Base de
Pasamanos
peso: 0,56 Kg/m

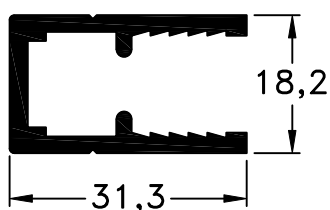

468 - Porta Vidrio
peso: 0,53 Kg/m

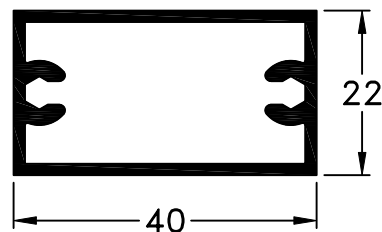

476 - Parante
peso: 0,61 Kg/m

Escala 1:1
Tolerancia en Peso +/- 10%

20-01-12 **SISTEMAS COMPLEMENTARIOS.11**

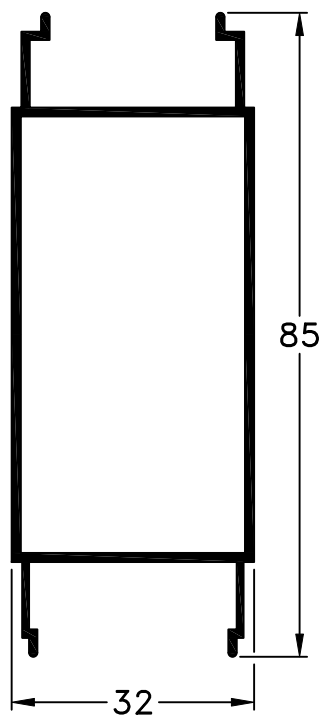

415 - Revestimiento Tubular
peso: 0,75 Kg/m

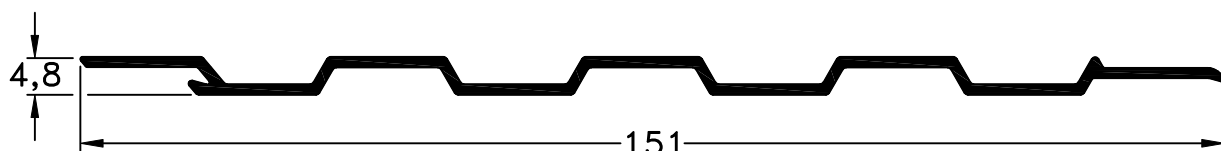

97 - Revestimiento Doble Faz
peso: 0,64 Kg/m

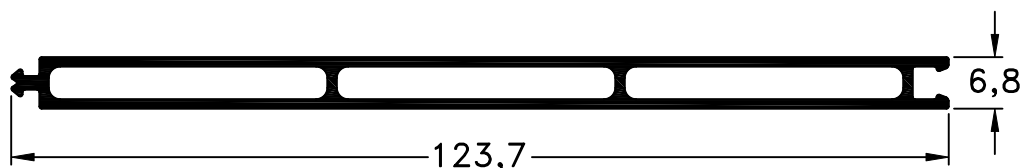

398 - Revestimiento Tubular
peso: 0,91 Kg/m

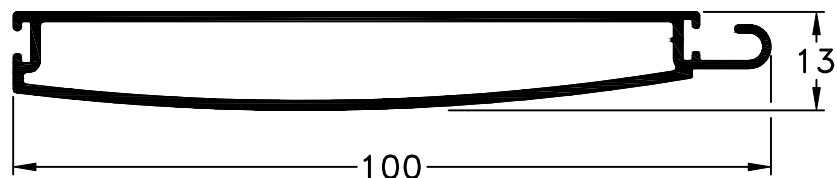

624 - Zócalo Cortina Común
Largo std.: 6150 mm
peso: 0,76 Kg/m

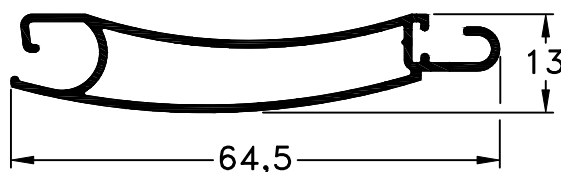

625 - Tablilla Cortina Común
Largo std.: 6150 mm
peso: 0,42 Kg/m

Código de Tablilla	
Ciega	Troquelada
625	325

Código de tablilla troquelada 325

Accesorios Requeridos

- 8600-0 Tapón Tablilla Común (T-102 / T-103)
8247-0 Felpa 5 x 5. (Tablilla)..... (C-10)
8248-0 Felpa 5 x 7. (zocalo)..... (C- 5)

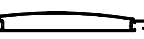
Dimensiones de Corte						
Código	Peso Kg/m	Forma	Función	Cant.	Largo	Corte
625 / 325	0,42		Tablilla	s/m	A - 13	90° 90°
624	0,76		Zocalo	1	A - 13	90° 90°

Escala 1:1

Tolerancia en Peso +/- 10%

20-01-12 **SISTEMAS COMPLEMENTARIOS.13**

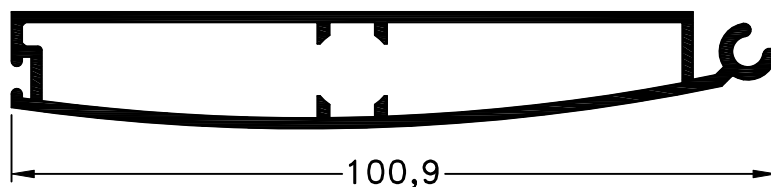

626 - Zócalo
peso: 0,90 Kg/m

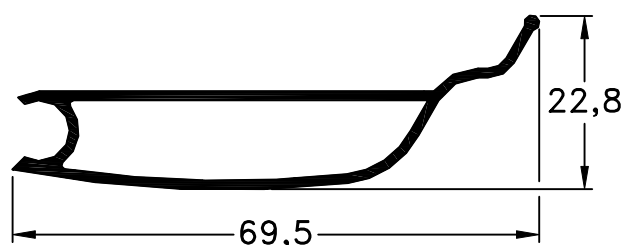

627 - Tablilla
de Comando
peso: 0,49 Kg/m



628 - Tablilla
Tubular
peso: 0,48 Kg/m

Accesorios Requeridos

Fraccionamiento

8603	AGO D	Tapón Lateral Tablilla (Derecho)	Bolsa x 100 u.
8604	AGO I	Tapón Lateral Tablilla (Izquierdo)	Bolsa x 100 u.
8605	AGR	Clavo Roscado Cabeza Chata (58 mm.)	Bolsa x 200 u.
8606	AGS 58	Fleje Armado con Ganchos	Rollo x 25 mts.
8607	AGT	Burlete Cubre Fleje	Rollo x 25 mts.
8608	AGU	Hebilla Terminal	Bolsa x 20 u.
8609	AGQ	Eslabón Cortina	Bolsa x 100 u.

Punzonado

9004 Punzón para Cortina Barrio

Escala 1:1

Tolerancia en Peso +/- 10%

20-01-12 **SISTEMAS COMPLEMENTARIOS.14**

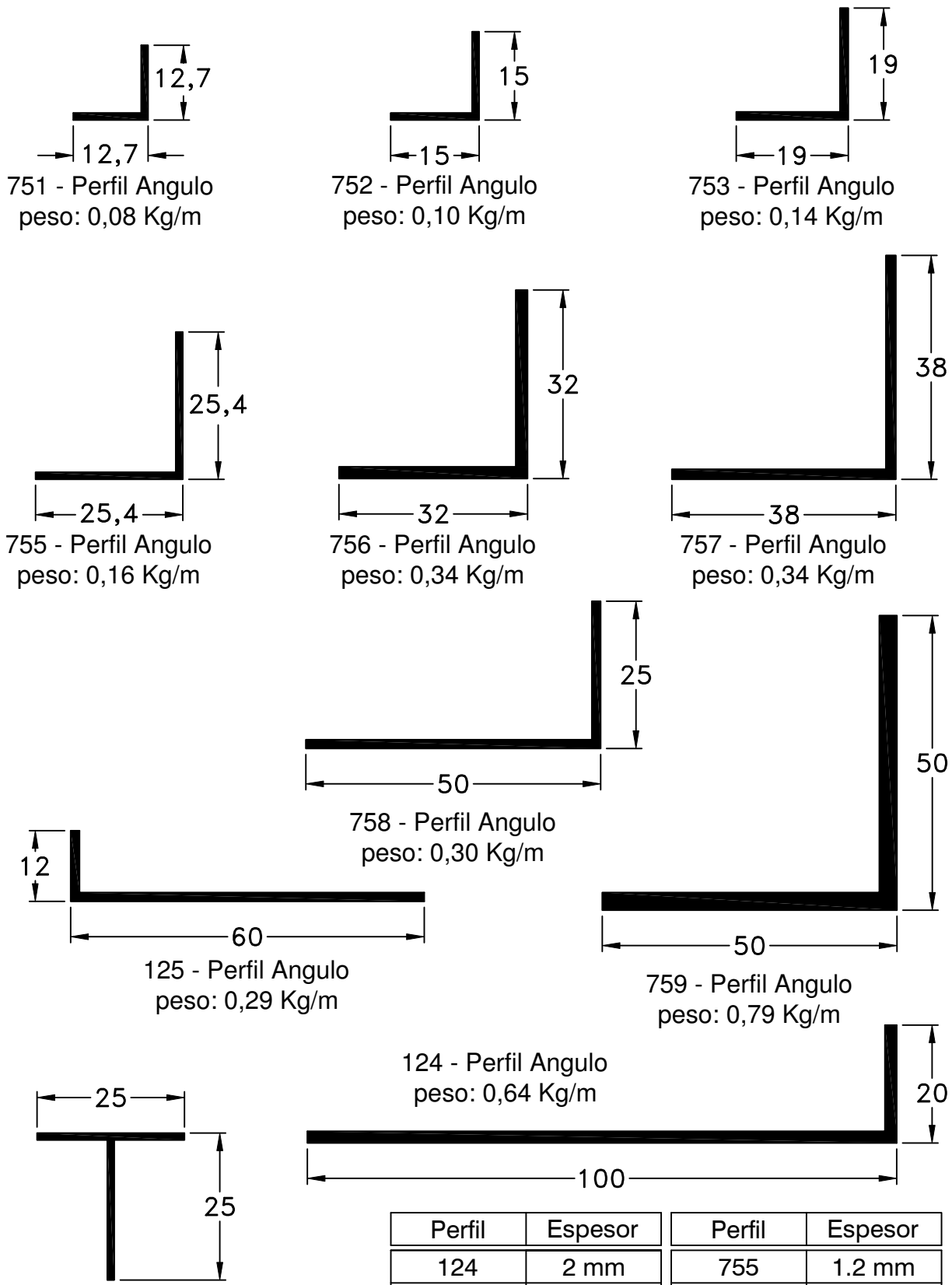

Perfil	Espesor	Perfil	Espesor
124	2 mm	755	1.2 mm
125	1.5 mm	756	2 mm
751	1.2 mm	757	1.7 mm
752	1.2 mm	758	1.5 mm
753	1.4 mm	759	3 mm
		830	1.2 mm

Escala 1:1
Tolerancia en Peso +/- 10%

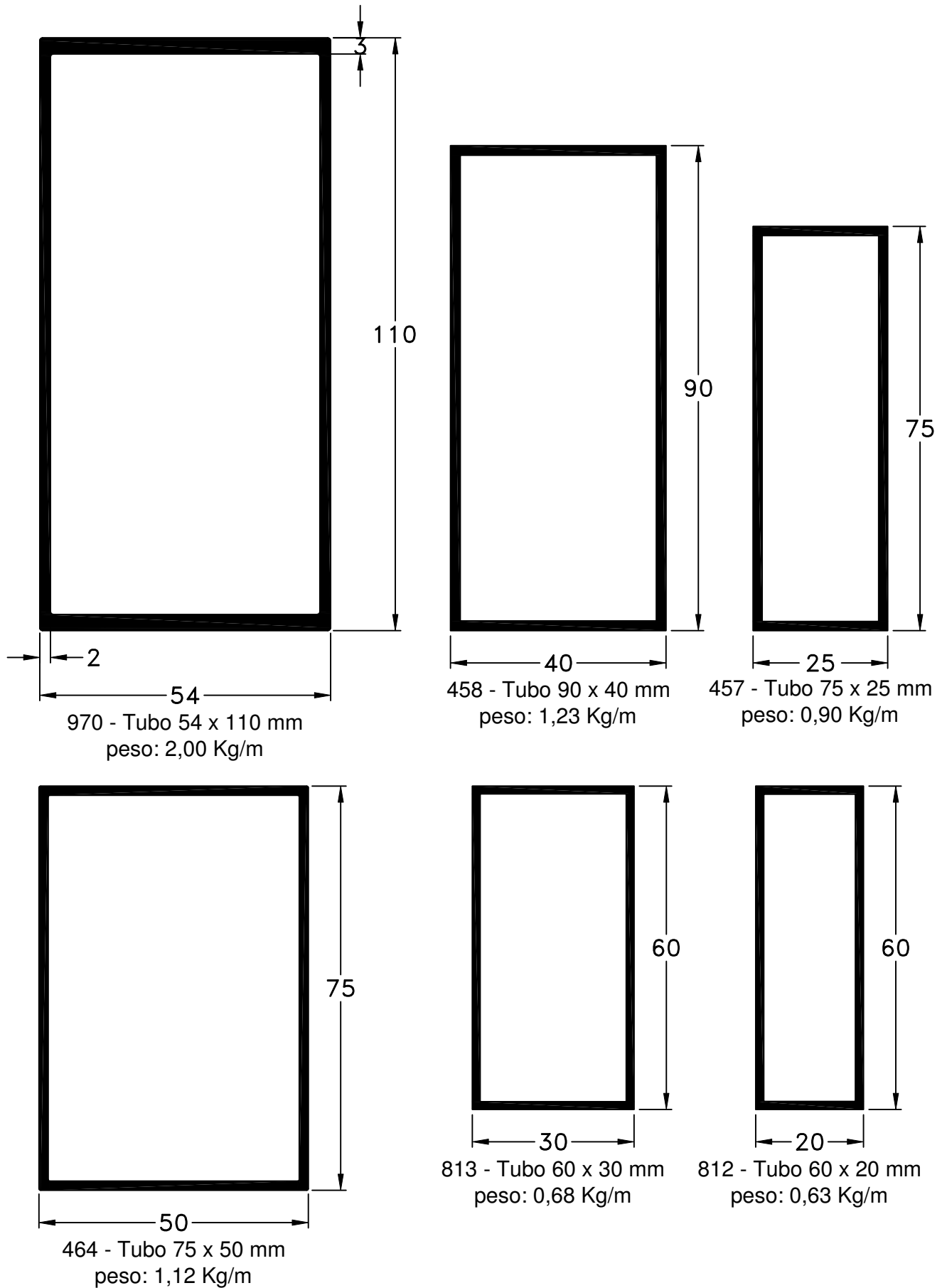

Escala 1:1

Tolerancia en Peso +/- 10%

20-01-12 **SISTEMAS COMPLEMENTARIOS.16**

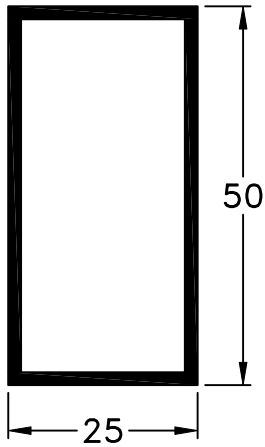

809 - Tubo 50 x 25 mm
peso: 0,55 Kg/m

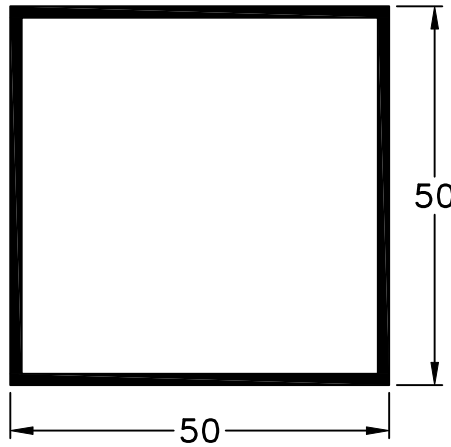

811 - Tubo 50 x 50 mm
peso: 0,79 Kg/m

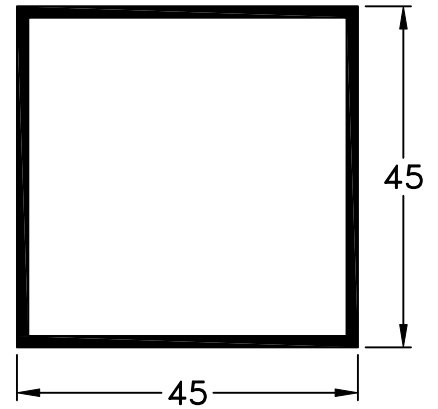

808 - Tubo 45 x 45 mm
peso: 0,71 Kg/m

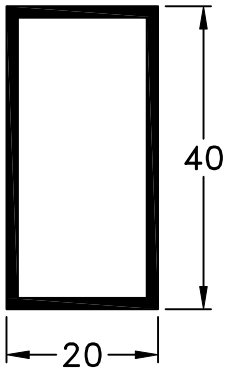

805 - Tubo 40 x 20 mm
peso: 0,46 Kg/m

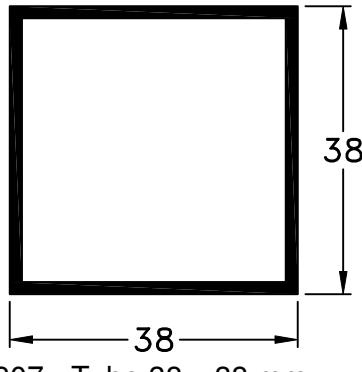

807 - Tubo 38 x 38 mm
peso: 0,63 Kg/m

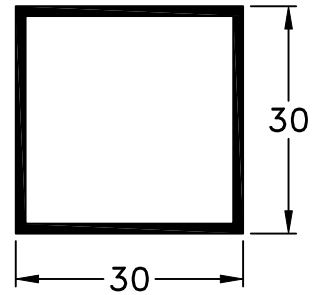

806 - Tubo 30 x 30 mm
peso: 0,40 Kg/m

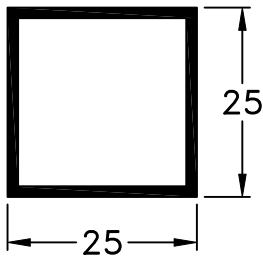

804 - Tubo Cuadrado
peso: 0,36 Kg/m

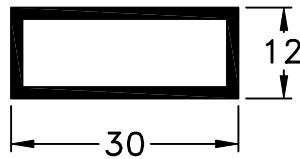

810 - Tubo Rectangular
peso: 0,32 Kg/m

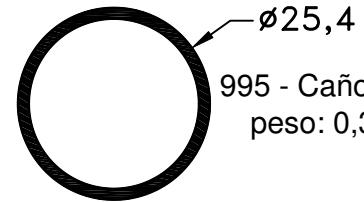

995 - Caño Redondo
peso: 0,31 Kg/m

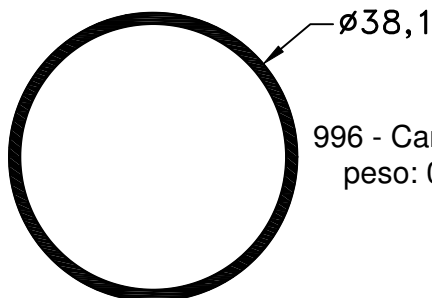

996 - Caño Redondo
peso: 0,47 Kg/m

Perfil	Espesor	Perfil	Espesor
457	1.7 mm	809	1.5 mm
458	1.8 mm	810	1.5 mm
464	1.7 mm	811	1.5 mm
804	1.4 mm	812	1.5 mm
805	1.5 mm	813	1.5 mm
806	1.3 mm	970	-
807	1.6 mm	995	1.5 mm
808	1.5 mm	996	1.5 mm

Escala 1:1

Tolerancia en Peso +/- 10%

Perfiles para Aereadores

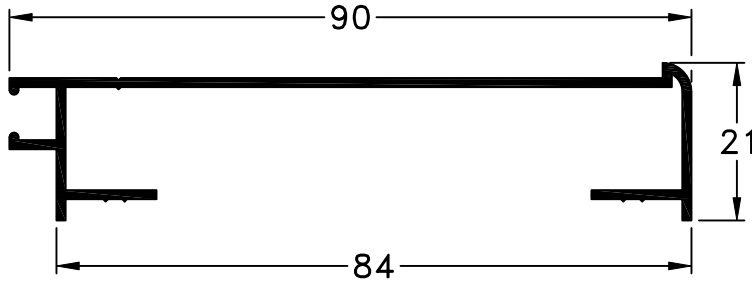

354 - Marco Aereador con Mosquitero
peso: 0,52 Kg/m

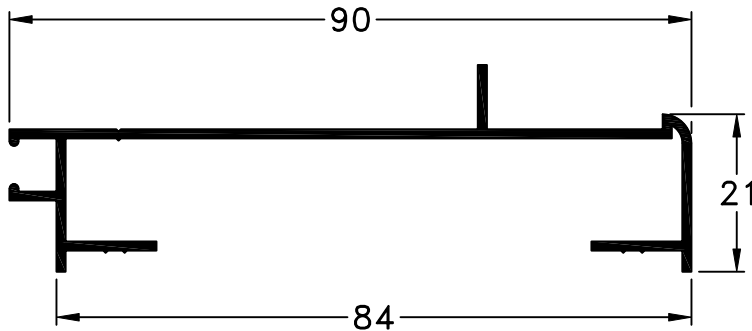

355 - Marco Aereador con Mosquitero
peso: 0,55 Kg/m

Adaptador para D.V.H.

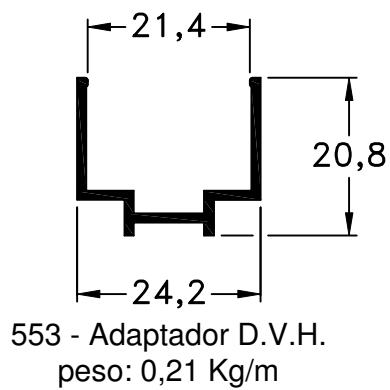

Perfil para Policarbonato

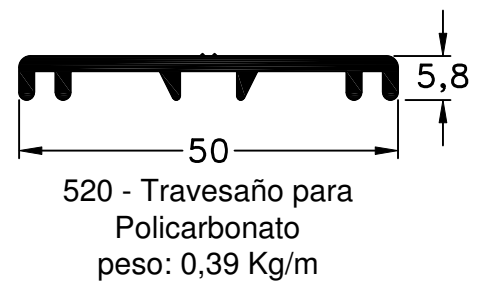

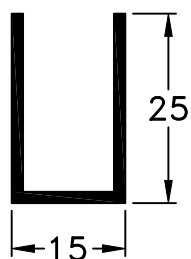

650 - "U" de Blindex
peso: 0,25 Kg/m

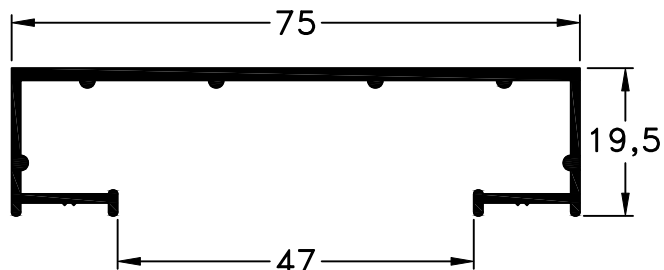

924 - Marco Recto
peso: 0,56 Kg/m

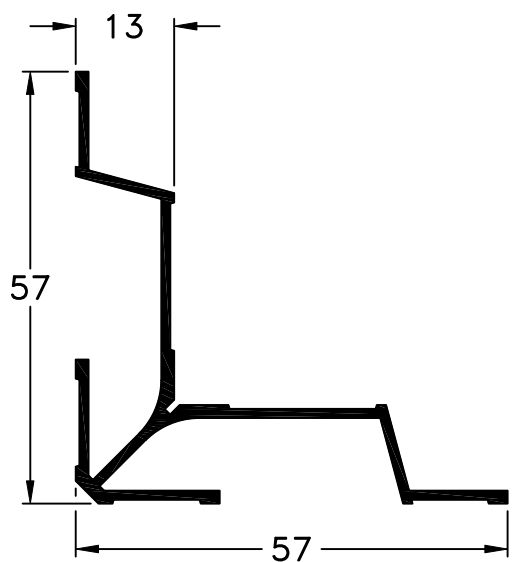

55 - Escuadra Universal Intermedia
peso: 0,56 Kg/m

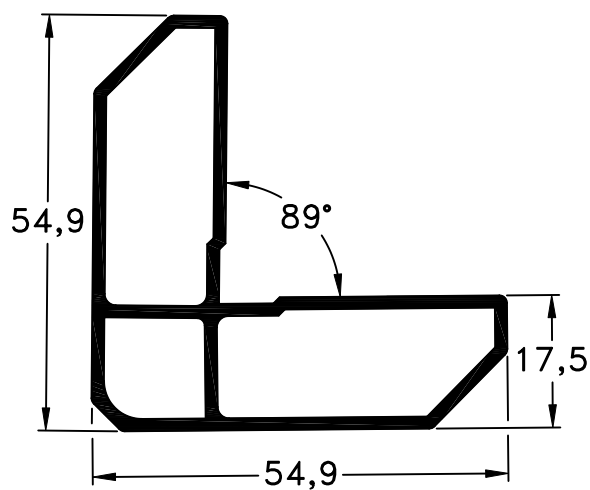

86 - Escuadra Suplementaria
peso: 1,00 Kg/m

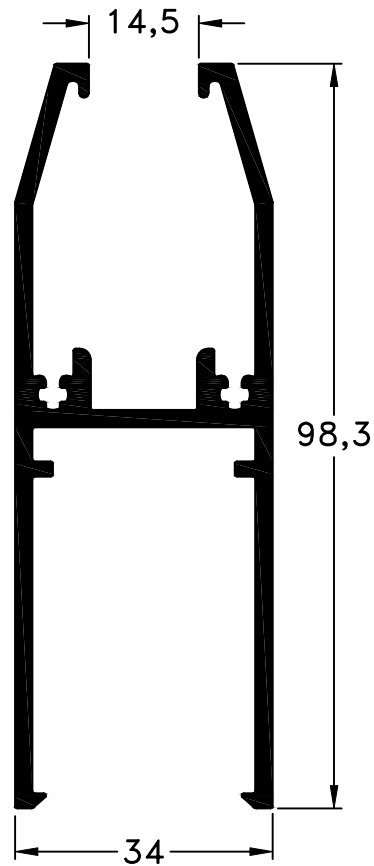

110 - Zócalo Puerta Blindex
peso: 1,66 Kg/m

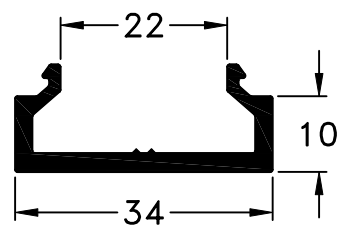

111 - Suplemento Zócalo
peso: 0,39 Kg/m

Accesorio Zócalo de Puerta Blindex - Paño Fijo				
Ítem	Código	Descripción	Forma	Cantidad
Tapa	9320-5	Tapa Lateral Zócalo de Puerta Blindex		s/m

s/m: según medida.

Escala 1:1

Tolerancia en Peso +/- 10%



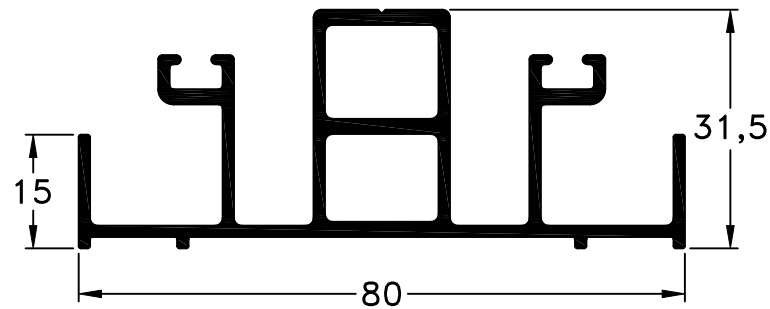

20-01-12 **SISTEMAS COMPLEMENTARIOS.20**

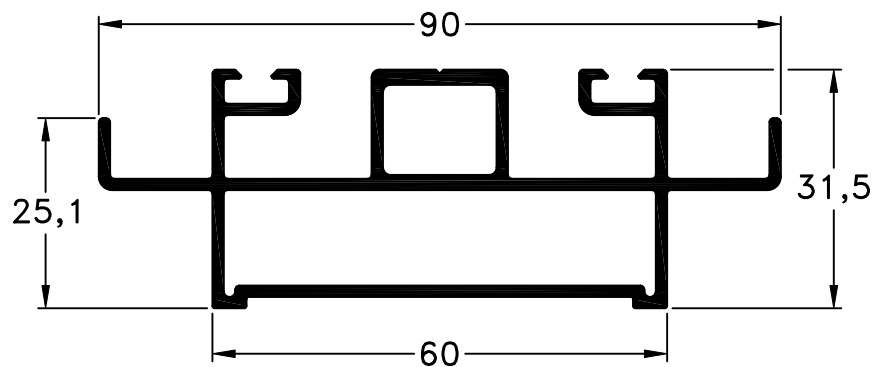

191 - Larguero de Techo
peso: 1,19 Kg/m



192 - Travesaño de Techo
peso: 1,27 Kg/m

Accesorio Perfiles de Techo				
Ítem	Código	Descripción	Forma	Cantidad
Burlete	9605	Burlete de Apoyo para Larguero		s/m
Burlete	9606	Burlete de Apoyo para Travesaño		s/m
Burlete	9607	Burlete para Junta Tomada en Travesaño		s/m
Burlete	9608	Burlete Adaptador para DVH en Larguero		s/m
Burlete	9609	Burlete Adaptador para DVH en Travesaño		s/m

s/m: según medida.

Escala 1:1

Tolerancia en Peso +/- 10%

20-01-12 **SISTEMAS COMPLEMENTARIOS.21**

Detalle de Larguero

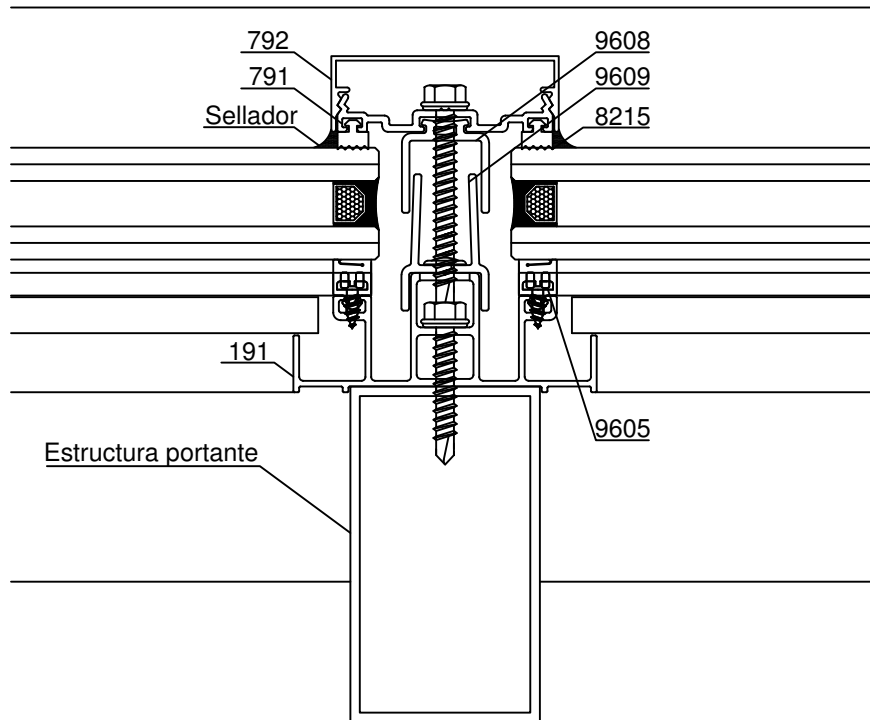



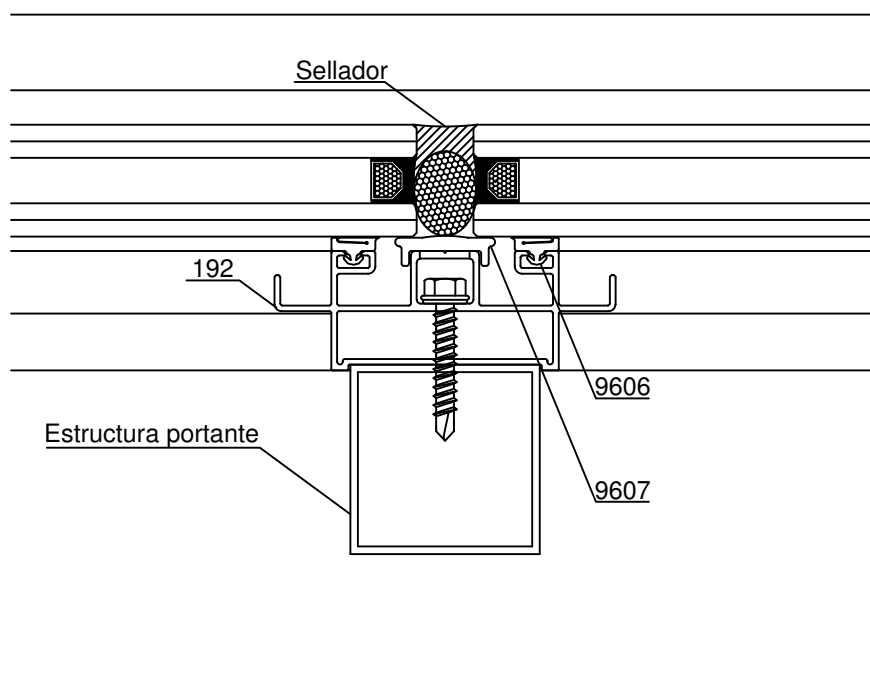





Detalle de Travesaño



Escala 1:2

Tolerancia en Peso +/- 10%

220-01-12 **SISTEMAS COMPLEMENTARIOS.22**





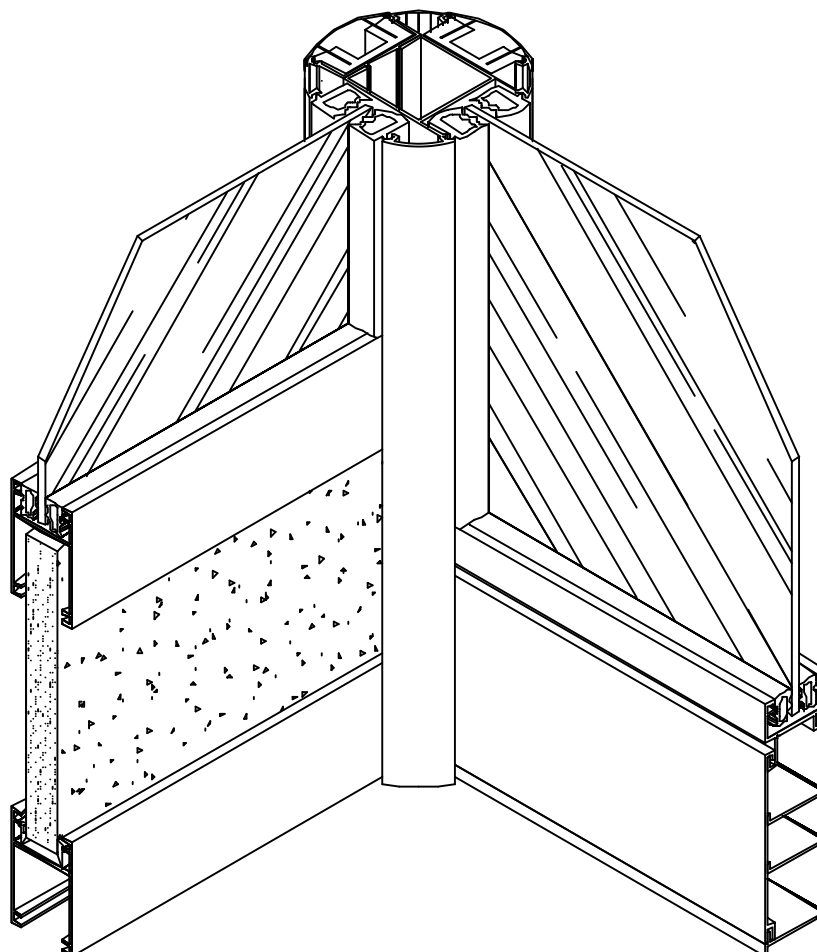

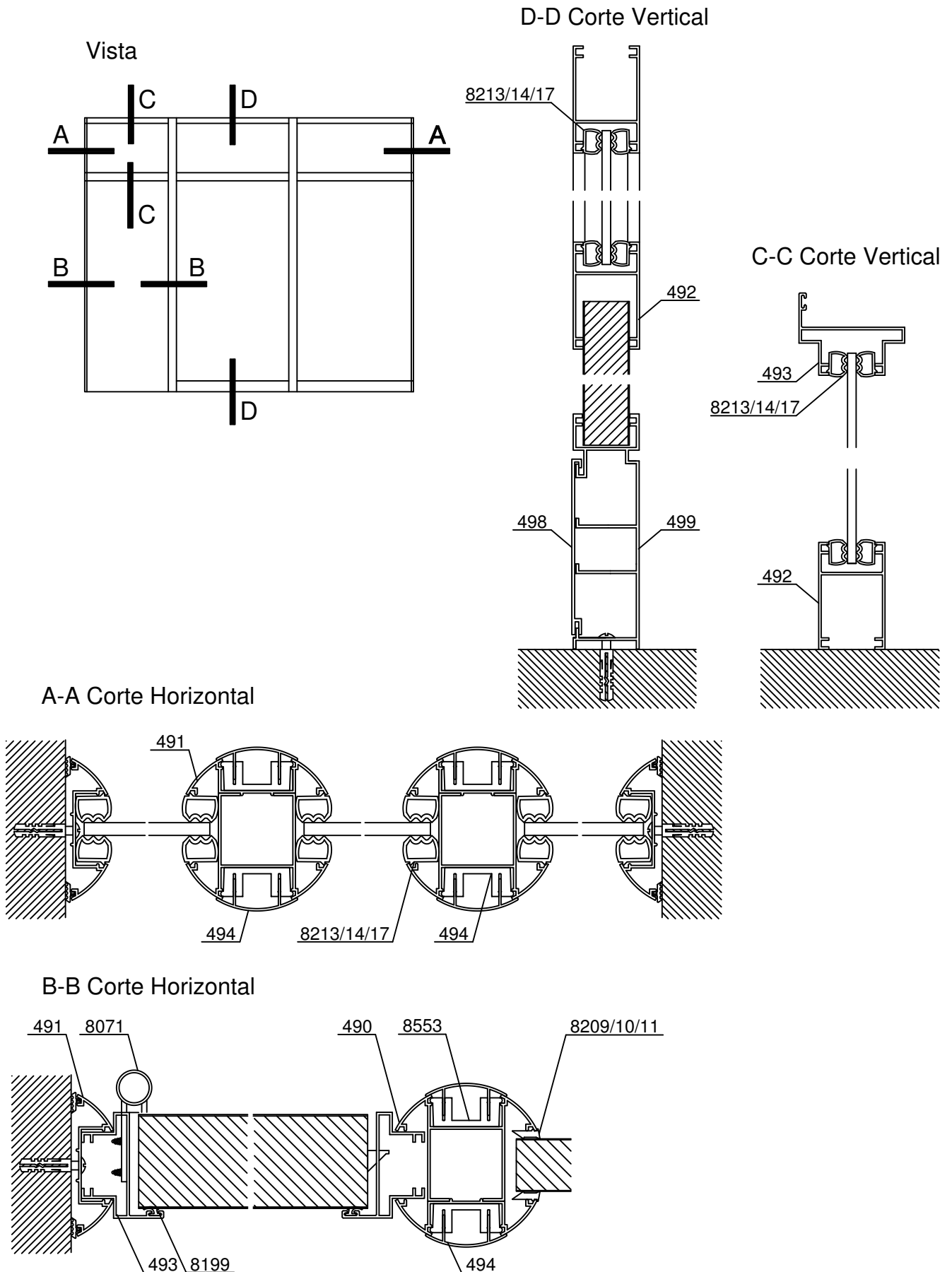

Accesorios Tabiquería Línea Alcemar				
Ítem	Código	Descripción	Forma	Cantidad
Cuña	8209	Cuña Chica		s/m
	8210	Cuña Mediana		
	8211	Cuña Grande		
Burlete P/Marco de Puerta 493	8914	Burlete Gabi III		s/m
	8199	Burlete Multi 2 para Marco de Puerta 493		s/m
Burlete P/Vidrio o Placa	8213	Burlete Cuña Hueca		s/m
	8214	Burlete "Tubo" de Tabiquería		s/m
	8217	Burlete "Tubito" de Tabiquería		s/m
Escuadra	8027	Escuadra Tabiquería "AFL"		s/m
Patín Exterior	8553	Clip para Tabiquería		s/m
Bisagra Pta. Placa	8071	Bisagra Munición de 100 x 75		s/m

s/m: según medida.





Escala 1:2.5
Tolerancia en Peso +/- 10%

Accesorios Tabiquería Tradicional				
Ítem	Código	Descripción	Forma	Cantidad
Cuña	8209	Cuña Chica		s/m
	8210	Cuña Mediana		
	8211	Cuña Grande		
Burlete P/Marco de Puerta 493	8914	Burlete Gabi III		s/m
	8199	Burlete Multi 2 para Marco de Puerta 493		s/m
Burlete P/Vidrio o Placa	8213	Burlete Cuña Hueca		s/m
	8214	Burlete "Tubo" de Tabiquería		s/m
	8217	Burlete "Tubito" de Tabiquería		s/m
Burlete Tapa	8226	Cinta de Terminación Tabiquería		s/m
Bisagra Pta. Placa	8071	Bisagra Munición de 100 x 75		s/m

s/m: según medida.

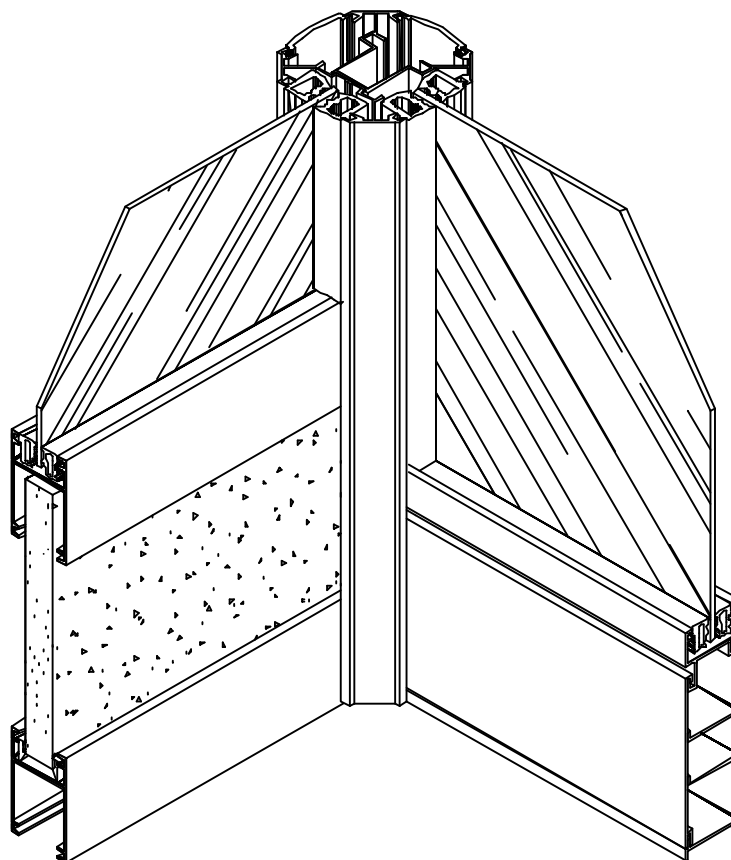

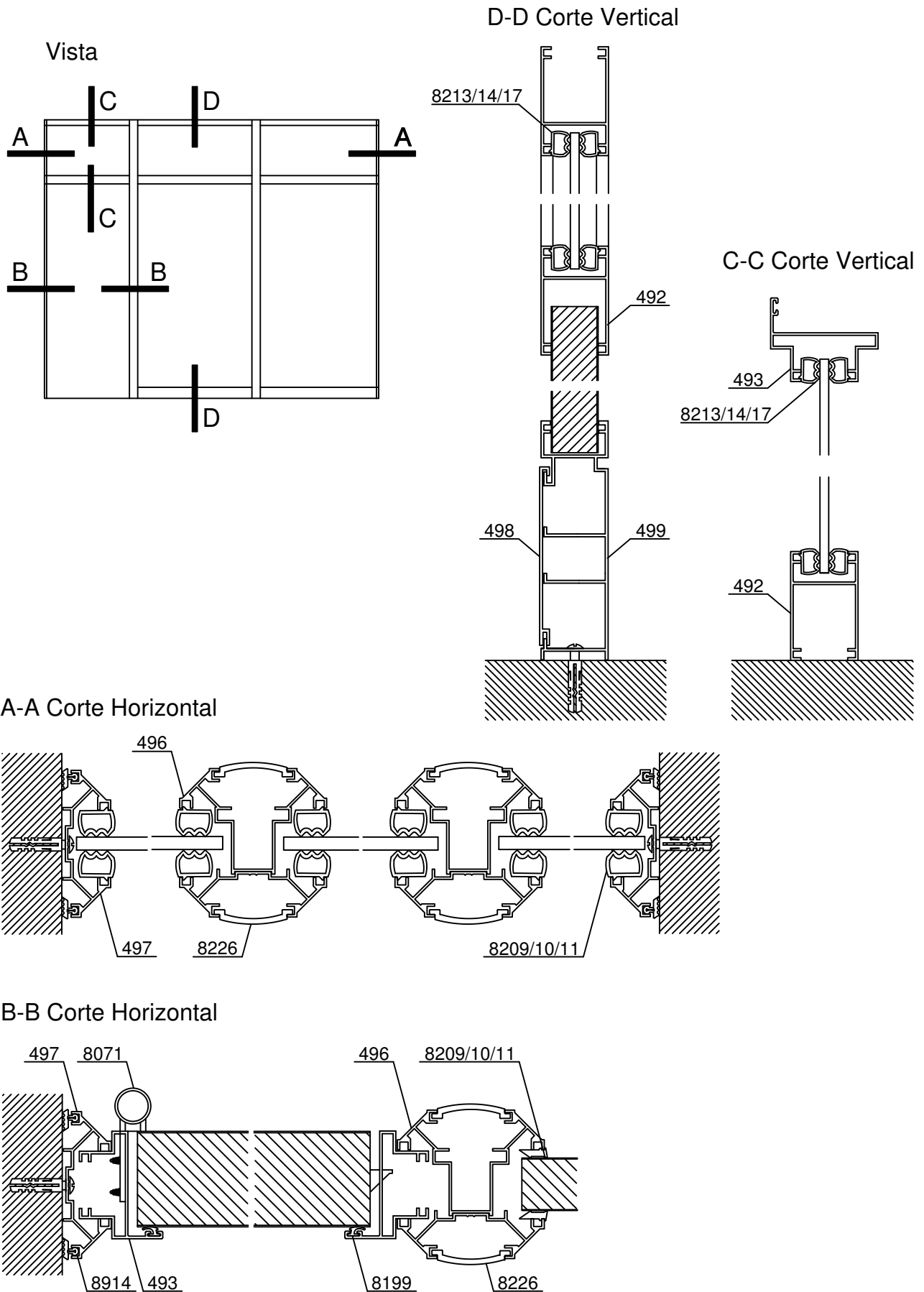

Escala 1:2.5
Tolerancia en Peso +/- 10%

Accesorios Mampara de Baño				
Ítem	Código	Descripción	Forma	Cantidad
Esc. de Armado	8014	Esc. de Hoja Parte "B" Pesada		8 Unidades
Rodamiento	8509	Rueda con Rulmán		4 Unidades
Toallero	8506	Toallero "RR"		2 Unidades
Riel	8514	Riel Sanitario "AEH"		s/m
Tope Plástico	8513	Tope Plástico de Seguridad "AEI"		2 Unidades
Burlete P/Acrílico	8205	Porta Acrílico "GG"		2A+4H
Burlete Tope	8219	Burlete Tope "AGM"		4H

s/m: según medida.

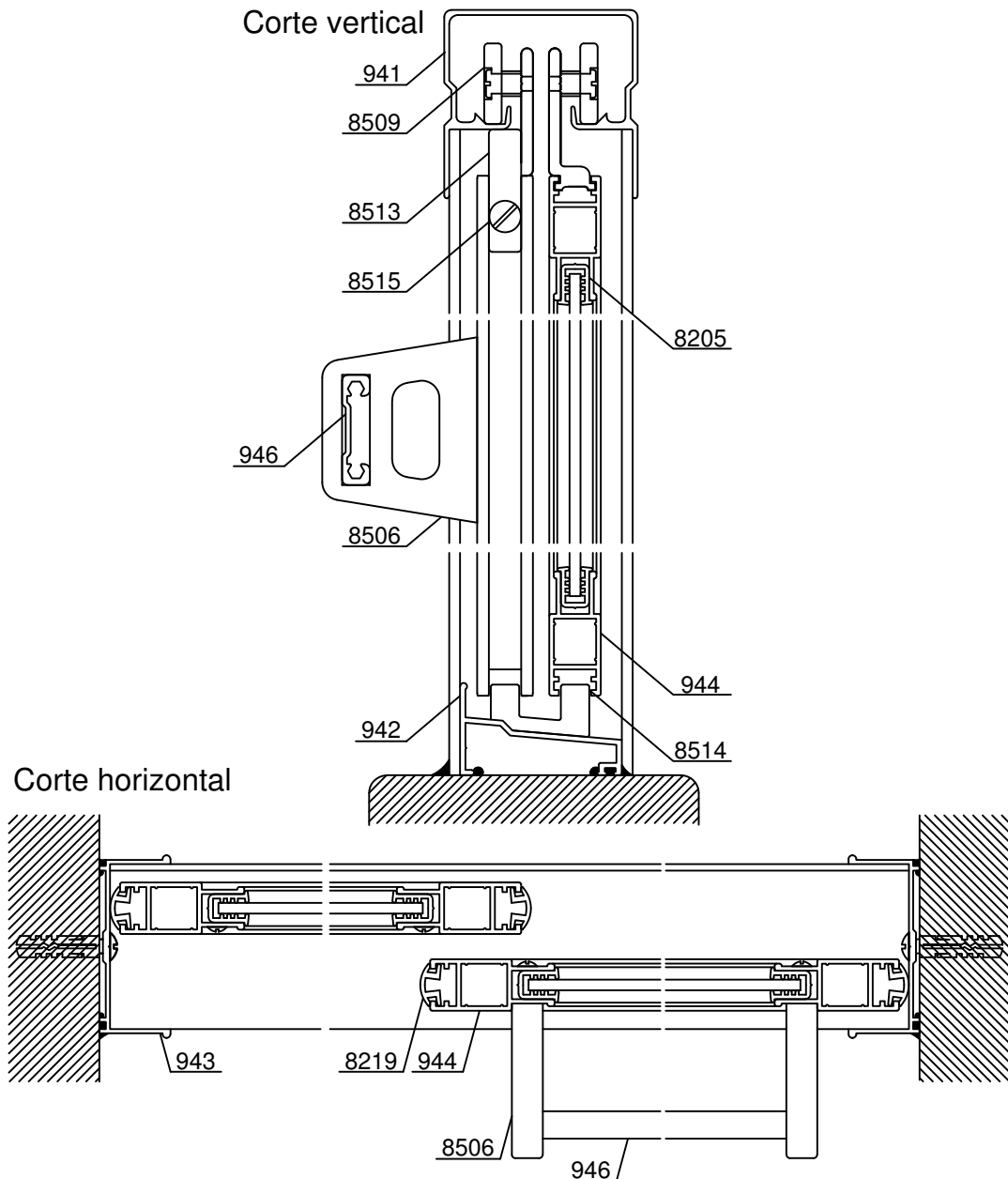

Escala 1:2.5

Tolerancia en Peso +/- 10%



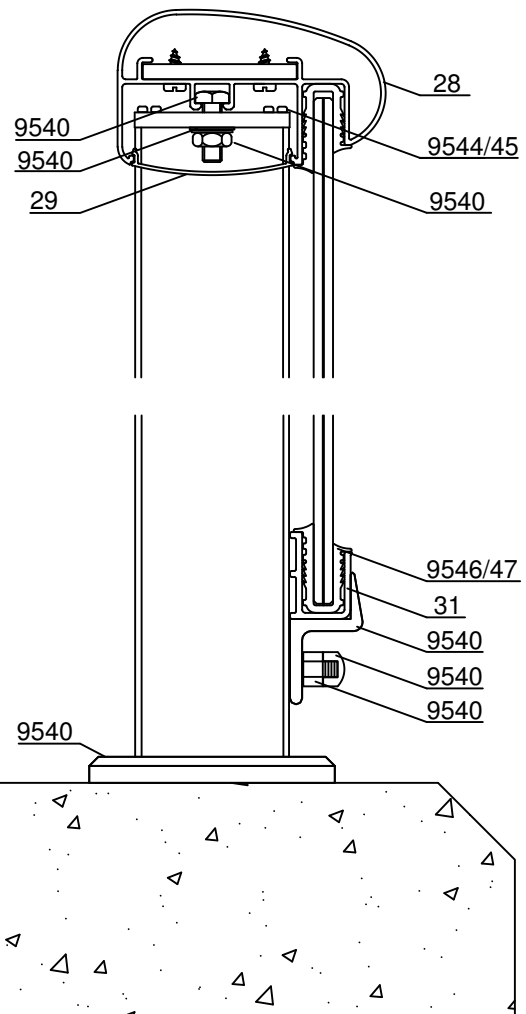
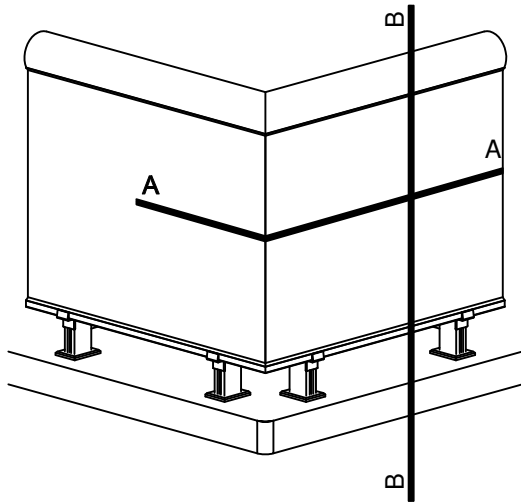

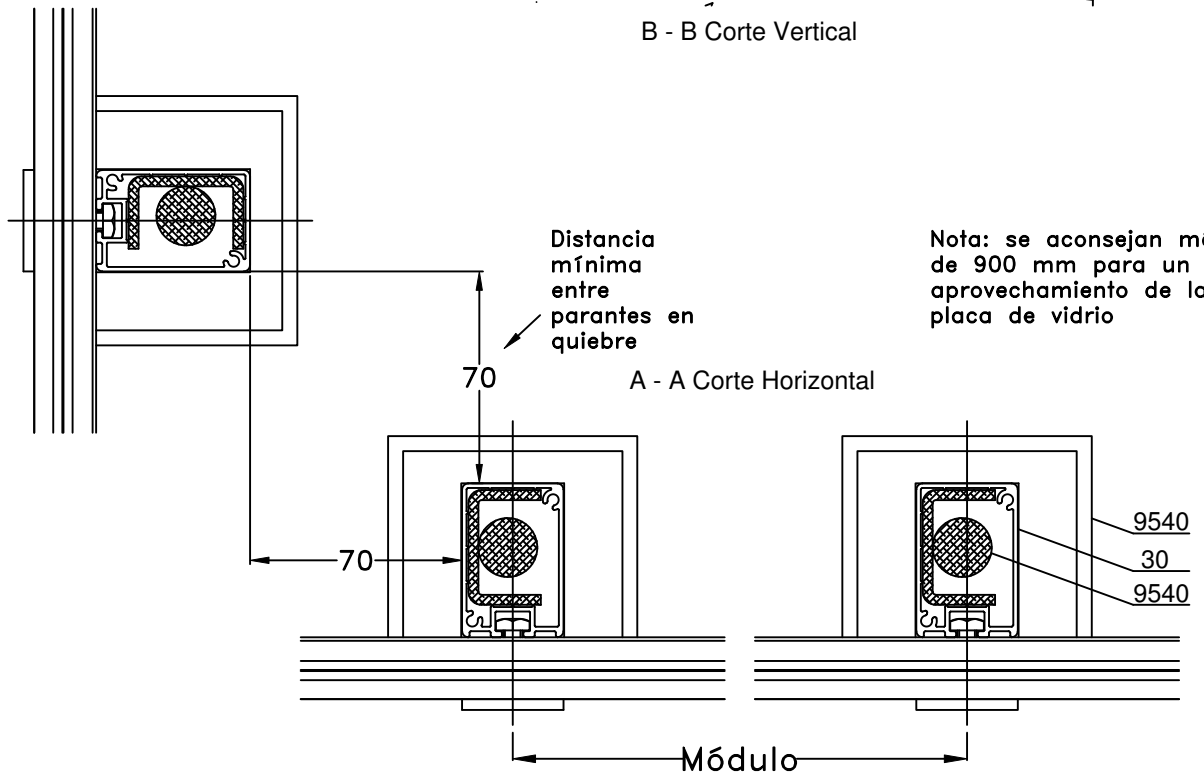

20-01-12 **SISTEMAS COMPLEMENTARIOS.27**



B - B Corte Vertical





Escala 1:2.5
Tolerancia en Peso +/- 10%

Accesorios Baranda BBA				
Ítem	Código	Descripción	Forma	Cantidad
Kit Baranda	9540	Kit Armado Baranda (zincado)		1 p/Parante
Kit Baranda	9542	Kit Armado Baranda (sin anclaje)		
Burlete Vidrio	9546	Burlete para vidrio laminado 3+3 mm		2 A
	9547	Burlete para vidrio laminado 4+4 mm		
Acople 180°	9549	Unión recta de pasamanos		1 p/acople
Acople 90°	9550	Unión a 90° de pasamanos		1 p/acople
Tornillo autorroscante	9544	Tornillo autorroscante N°10x16 mm (Zinc.)		2 p/Parante y 8 p/Acople
	9545	Tornillo autorroscante N°10x16 mm (A° I°)		
Acople 135°	9551	Unión a 135/45° de pasamanos		1 p/acople
Tapa	9552	Tapa lateral Pasamano		1 par p/pasamano





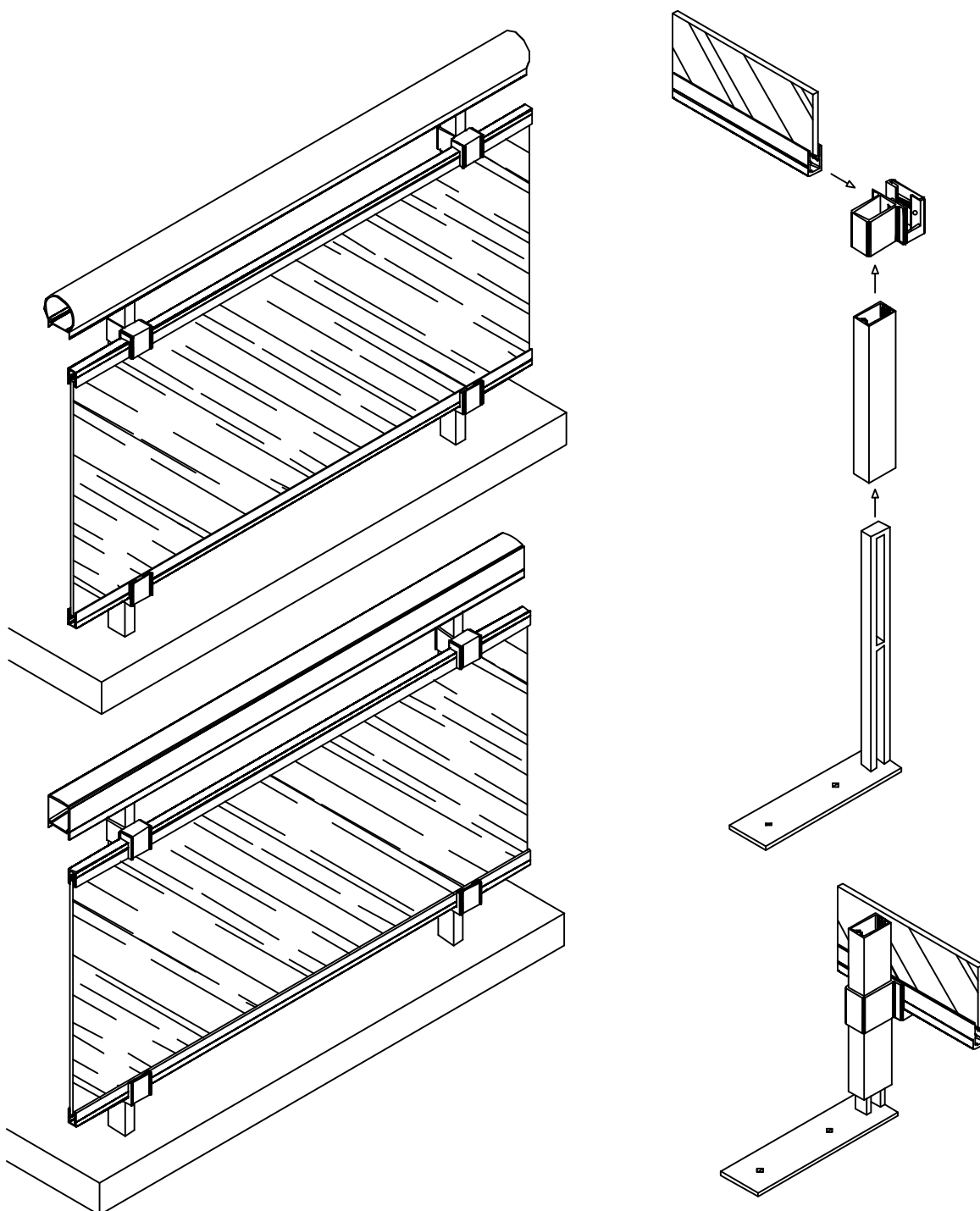

A = Ancho baranda

Nota: El kit para baranda incluye, un anclaje (zincado), una placa de fijación parante - pasamanos, tres bulones cab. exag. RW $\frac{1}{4}$ x1" (zincados), una tuerca autoblocante RW $\frac{1}{4}$ (zincado), dos tuercas RW $\frac{1}{4}$ (Zincados), dos arandelas $\frac{1}{4}$ (zincados) , un capuchon de poliamida 6.6, un soporte p/ vidrio y una tapa parante inferior.

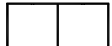
Accesorios Baranda Clásica				
Ítem	Código	Descripción	Forma	Cantidad
Anclaje	8302	Anclaje de Acero Zincado		s/m
Soporte	8305	Soporte Porta Blisan (Natural, Blanco o Negro)		s/m
Burlete	8304	Burlete para Blisán de 6 a 8 mm. "B-33"		s/m



s/m: según medida.

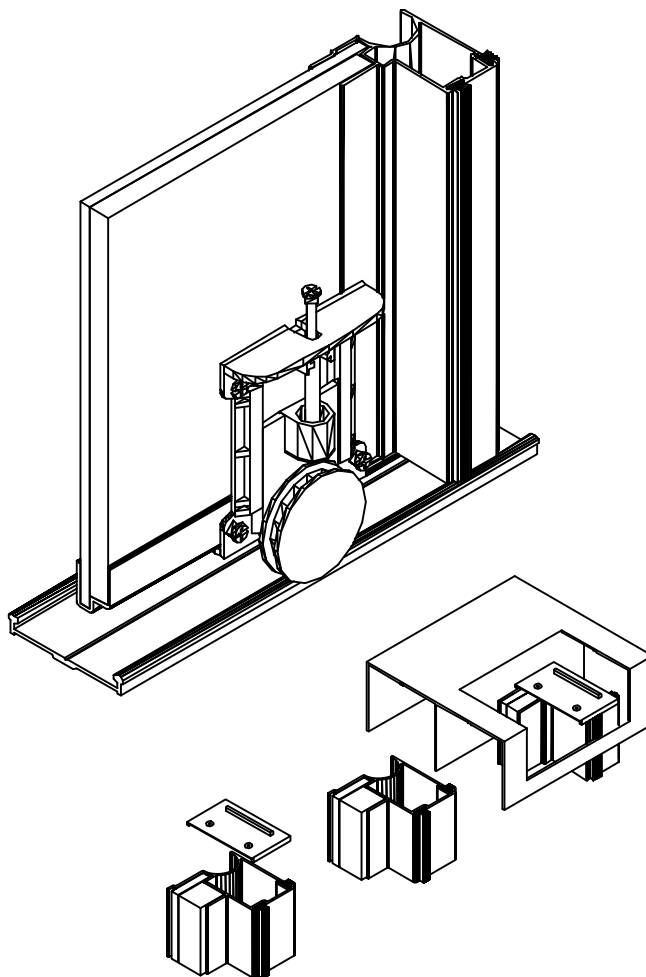

Dimensiones de Corte						
Código	Peso Kg/m	Forma	Función	Cant.	Largo	Corte
160	0,68		Guía Superior	1	A	90° 90°
157	0,25		Guía Inferior	1	A	90° 90°
156	0,16		Cantoneira 15mm	2	A/2-66	90° 90°
155	0,53		Parante 15mm	4	H-32	90° 90°
158	0,20		Cantoneira 18mm	2	A/2-57	90° 90°
159	0,54		Parante 18mm	4	H-32	90° 90°

* Medidas en milímetros



Accesorios Placard de 2 Hojas				
Ítem	Código	Descripción	Forma	Cantidad
Kit	8729	Kit de Placard para Parante 155		1 Kit
Kit	8730	Kit de Placard para Parante 159		1 Kit
Felpa	8243	Felpa de Polipropileno 7x4,5		5H

s/m: según medida.

Tolerancia en Peso +/- 10%

20-01-12 **SISTEMAS COMPLEMENTARIOS.31**