

B-B Corte Vertical

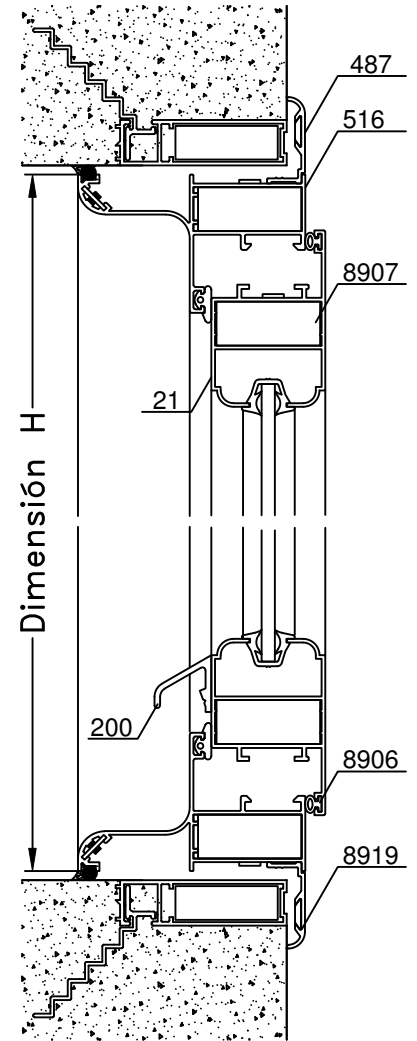

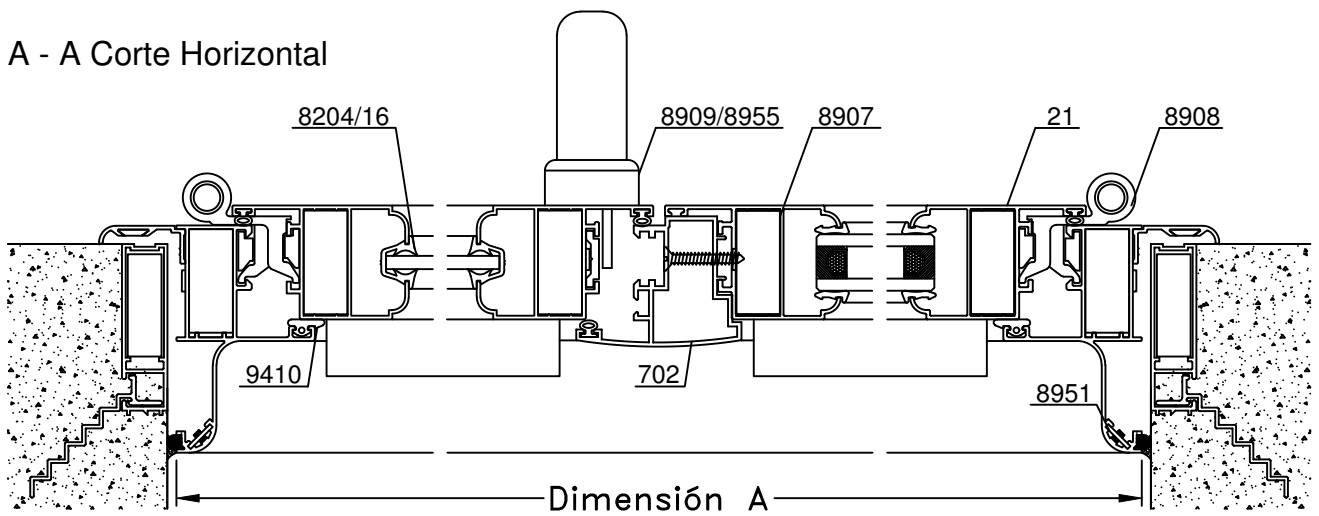





A - A Corte Horizontal



Escala 1:2.5

Tolerancia en Peso +/- 10%













20-01-12 **GAMMA.22**

Dimensiones de Corte						
Código	Peso Kg/m	Forma	Función	Cant.	Largo	Corte
516	0,76		Marco	2	A	45° 45°
				2	H	45° 45°
20	0,68		Hoja	4	A/2-21	45° 45°
				4	H-37	45° 45°
21	0,65		Hoja	4	A/2-21	45° 45°
				4	H-37	45° 45°
702	0,81		Inversor	1	H-97	90° 90°
Varilla 9469 o Perfil 703	0,07 (Varilla) 0,16 (Perfil)		Pletina	2	S/F	90° 90°
200	0,15		Bota-Agua	1	A/2-82	90° 90°
				1	A/2-77	90° 90°
487	0,17		Contra - Marco	2	A+51	45° 45°
				2	H+51	45° 45°

Dimensiones de Corte Premarco: pág. 11

S/F: Según Falleba

* Medidas en milímetros

Detalle de Accesorios				
Ítem	Código	Descripción	Forma	Cantidad
Esc. de Armado	8907	Escuadra de Armado A-700		12 Unidades
Esc. Alineación	8951	Escuadra de Alineación		4 Unidades
Burlete Vidrio	8204	Burlete Universal B-7		2A + 4H
	8216			
Cuña Vidrio	8209	Cuña Chica		2A + 4H
	8210	Cuña Mediana		
	8211	Cuña Grande		
Burlete Hermetic.	8906	Burlete AEL europeo		2A + 4H
	9410	Burlete Exterior B-80		2A + 2H
Falleba	8909	Falleba Prima H-47 con Kit		1 Unidad
	8955	Falleba Nova H-86 con Kit		
Traba Varilla	9129	Traba Varilla Doble H-78		2 Unidades
Bisagra	8908	Bisagra H-61 de 2 piezas con Kit		4 Unidades
Pasador	8910	Pasador H-49		2 Unidades
Tapón Inversor	8915	Tapón Inversor de Hoja		1 Par
Sostén de Hoja	8433	Sostén de Hoja H-44	—	2 Unidades
Tapa Desagüe	8366	Tapa Desagüe T-69		2 Unidades

s/m: según medida.

Accesorios Premarco: pág. 11

Nota: Es posible utilizar los marcos 70 y 75. Los descuentos de corte son los mismos que se detallan en la página 21; excepto el ancho de la Hoja que debe ser: Hoja 020/021 - Descuento A/2 - 27.