

Paño Fijo para
Colocación del Vidrio
desde Interior o Exterior

B-B Corte Vertical

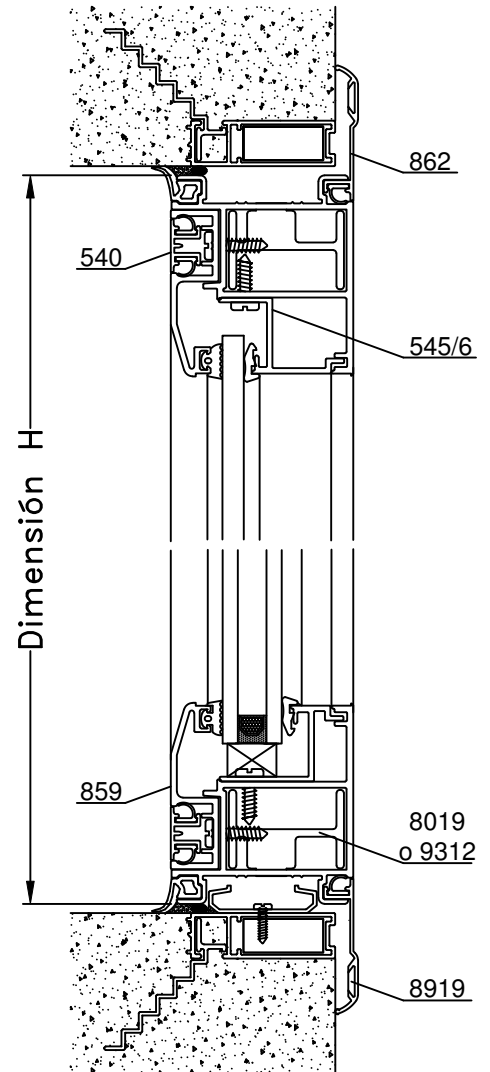

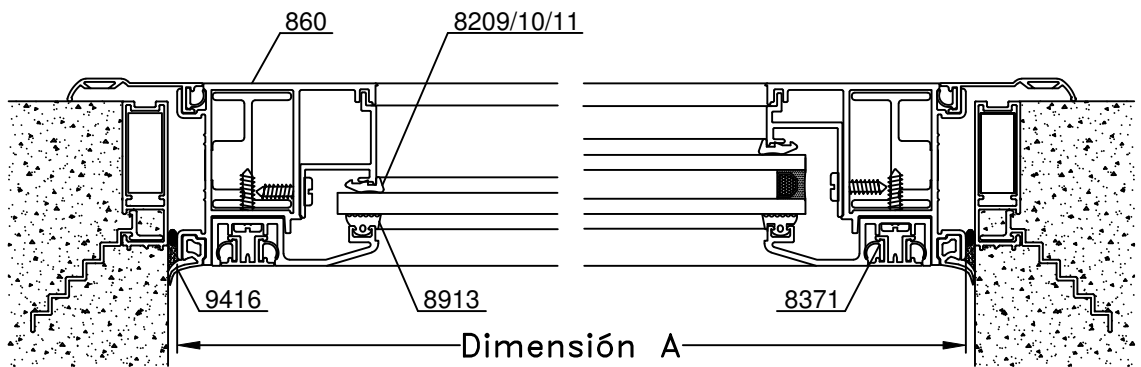

A-A Corte Horizontal





Escala 1:2.5

Tolerancia en Peso +/- 10%

20-01-12 **MEDITERRANEA.72**







| Dimensiones de Corte | | | | | | |
|----------------------|-----------|---|-----------------|-------|-------|---------|
| Código | Peso Kg/m | Forma | Función | Cant. | Largo | Corte |
| 860 | 1,19 |  | Marco | 2 | A | 45° 45° |
| | | | | 2 | H | 45° 45° |
| 859 | 0,57 |  | Soporte Vidrio | 2 | A-23 | 45° 45° |
| | | | | 2 | H-23 | 45° 45° |
| 540 | 0,15 |  | Tapa Soporte | 2 | A-29 | 45° 45° |
| | | | | 2 | H-29 | 45° 45° |
| 545/546 611/612 | - | - | Contra - Vidrio | 2 | A-81 | 45° 45° |
| | | | | 2 | H-81 | 45° 45° |

| Código | Forma |
|--------|---|
| 545 |  |
| 546 |  |

Dimensiones de Corte Contramarco: pág. 30

* Medidas en milímetros

Dimensiones de Corte Premarco: pág. 31

| Detalle de Accesorios | | | | |
|-----------------------|--------|--|---|------------|
| Ítem | Código | Descripción | Forma | Cantidad |
| Esc. de Armado | 8019 | Escuadra de Armado Descentrada E-22 |  | 4 Unidades |
| | 9312 | Escuadra de Expansión Descentrada E-22e | | |
| Tornillo | - | Tornillo de Fijación Perfil Soporte |  | s/m |
| | - | Tornillo de Fijación Perfil Contravidrio |  | s/m |
| Clip | 8371 | Clip Mediterránea |  | s/m |
| Burlete Vidrio | 8913 | Burlete de Acristalamiento B-68 |  | 2A + 2H |
| Cuña Vidrio | 8209 | Cuña Chica |  | 2A + 2H |
| | 8210 | Cuña Mediana | | |
| | 8211 | Cuña Grande | | |
| Burlete Exterior | 9416 | Burlete Exterior Cubre Sello |  | 2A + 2H |

s/m: según medida

Accesorios Contramarco: pág. 30 Accesorios Premarco: pág. 31