

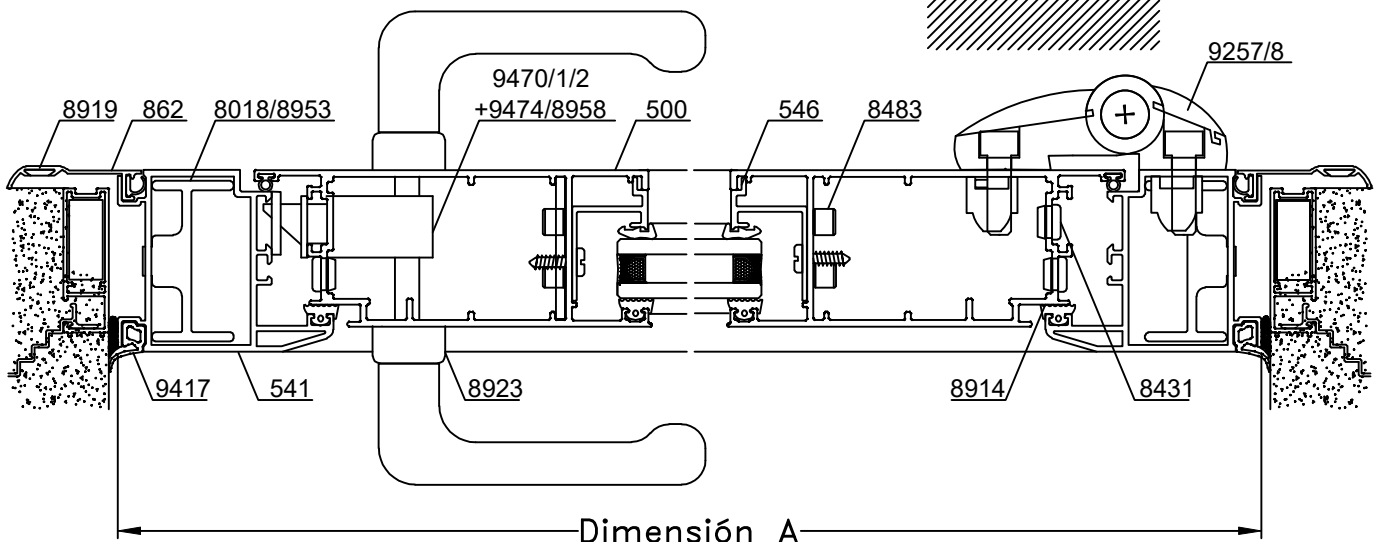

A-A Corte Horizontal



Escala 1:2.5

Tolerancia en Peso +/- 10%















12-12-16 **MEDITERRANEA.64**

Dimensiones de Corte				Parante y Cabezal 547			Parante y Cabezal 543		
Código	Peso Kg/m	Forma	Función	Cant.	Largo	Corte	Cant.	Largo	Corte
541	1,57		Marco	1	A	45° 45°	1	A	45° 45°
				2	H	45° 90°	2	H	45° 90°
547	1,66		Hoja	1	A-90	45° 45°	-	-	-
				2	H-51	45° 90°	-	-	-
500	2,17		Hoja	-	-	-	1	A-90	45° 45°
				-	-	-	2	H-50	45° 90°
542	2,55		Zócalo	1	A-234	90° 90°	1	A-300	90° 90°
545/546 611/612	-	-	Contra - Vidrio	2	A-234	45° 45°	2	A-300	45° 45°
				2	H-228	45° 45°	2	H-261	45° 45°

Dimensiones de Corte Contramarco: pág. 27

* Medidas en milímetros

Dimensiones de Corte Premarco: pág. 28

Detalle de Accesorios					
Ítem	Código	Descripción	Forma	Cantidad	
Esc. de Armado	8018	Escuadra de Armado Pesada E-20		2 Unidades	
	8953	Escuadra de Expansión E-20e			
	Esc. de Armado	8019	Escuadra de Armado Descentrada E-22		2 Unidades
		9312	Escuadra de Expansión Descentrada E-22e		
	Esc. de Armado	8030	Escuadra Suplementaria de 46 mm		2 Unidades
		8031	Escuadra de Alineación de 46 mm (756)		
Burlete Vidrio	8913	Burlete de Acristalamiento B-68		2A + 2H	
Cuña Vidrio	8209	Cuña Chica		2A + 2H	
	8210	Cuña Mediana			
	8211	Cuña Grande			
Burlete Hermetic.	8906	Burlete AEL europeo		1A + 2H	
	8914	Burlete Gabi III		1A + 2H	
Burlete Exterior	9417	Burlete Exterior Cubre Sello		1A + 2H	
Picaporte	8923	Manija Prima H-93		1 Unidad	
Cerradura	9470+9474	Cerrad. TESA (España)Basc.+ Cilindro		1 Unidad	
	9471+9474	Cerrad. TESA (España)Basc. Ref.+ Cilindro			
	9472+9474	Cerrad. Multip.TESA (España) + Cilindro			
Bisagras	8958	Cerradura Kallay 2006		3 Unidades	
	9258	Bisagra Domina de 3 Alas H-104			
	9257	Bisagra Domina de 2 Alas H-103			
Felpa	8942	Felpa de 7x6		2A	
Tornillos	8483	Tornillos Allen de RW $\frac{1}{4}$ x $\frac{3}{4}$ mm		8 Unidades	
Tapa Tornillos	8431	Tapa de Tornillo T-100		8 Unidades	
Tornillo	-	Tornillo de Fijación Perfil Contravidrio		s/m	

s/m: según medida - Accesorios Contramarco: pág. 27 - Premarco: pág. 28 - Umbral Transitable: pág. 32