

B-B Corte Vertical

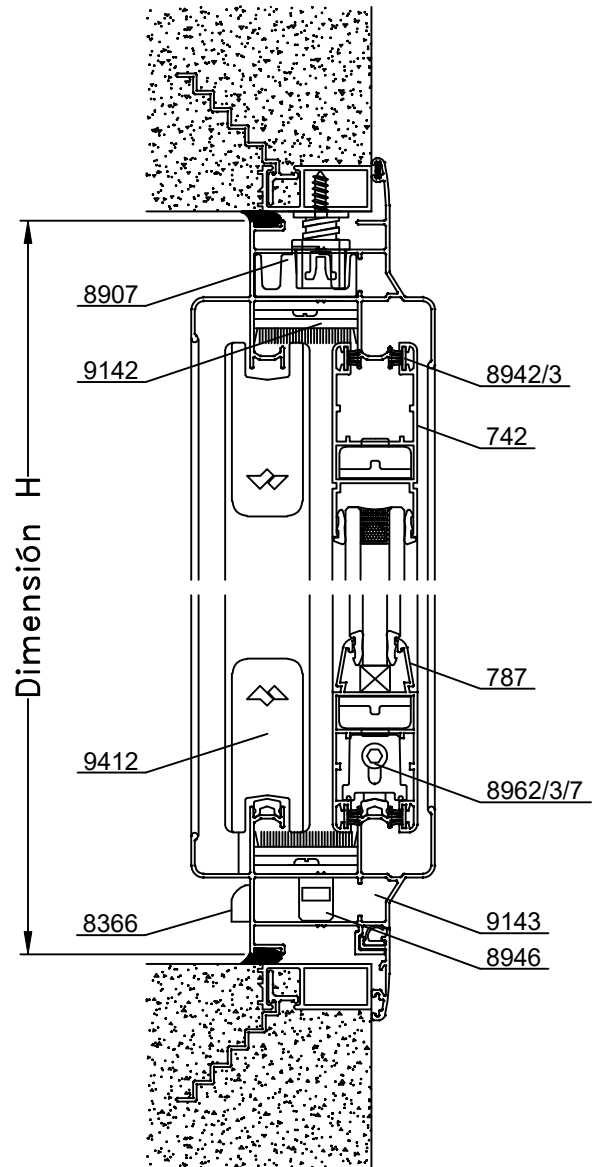

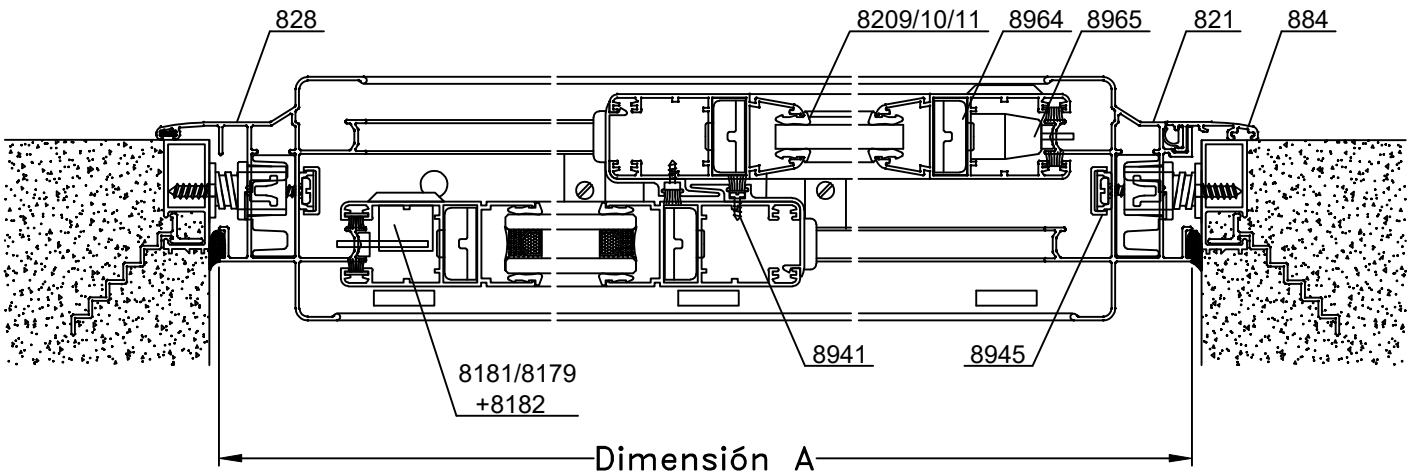





A-A Corte Horizontal

















Escala 1:2.5  
Tolerancia en Peso +/- 10%

02-10-17 **MONACO.36**

Dimensiones de Corte						
Código	Peso Kg/m	Forma	Función	Cant.	Largo	Corte
821	1,04		Marco	2	A	45° 45°
				2	H	45° 45°
828	1,12		Marco	2	A+41	45° 45°
				2	H+41	45° 45°
561	0,09		Guía Inf. Marco	2	A-92	90° 90°
787	0,76		Hoja	4	A/2-8	45° 45°
742	0,76			4	H-81	45° 45°
743	0,29		Encuentro Central	2	H-81	90° 90°
730	0,80		Travesaño p/787	2	A/2-101	90° 90°
681	0,70		Travesaño p/742	2	A/2-101	90° 90°

Dimensiones de Corte Contramarco: pág. 17 \* Medidas en milímetros

Dimensiones de Corte Premarco: pág. 17 y 18

Detalle de Accesorios				
Ítem	Código	Descripción	Forma	Cantidad
Esc. de Armado	8907	Escuadra de Armado A-700		4 Unidades
	8890	Esc. de Armado A - 700 de Expansion		
	8964	Escuadra Armado de Hoja CON-359		
Esc. Alineación	8949	Escuadra de Alineamiento Hoja E-98		16 Unidades
Tornillos	8941	Tornillo Fijador Perfil 743		s/m
Cuña Vidrio	8209	Cuña Chica		4A + 8H
	8210	Cuña Mediana		
	8211	Cuña Grande		
Felpa	8942	Felpa de 7x6		4A + 6H
	8943	Felpa de 7x6 con Fin Seal		
Manija	9440	Manijas Acodadas Modelo SR Izq / Der	-	2 Unidades
	9452	Manija Recta Modelo SR		
Cierre Lateral	9430/31/32	Mecanismo de Cierre de 1 , 2 y 3 Puntos	-	2 Unidades
	8181/8179	Cierre Lateral Milano Autom./Manual 2 Pos.		
	8182	Kit de Cierre Lateral Milano		
Tope Lateral	8965	Tope Lateral BAT-937		1 Juego
Rodamientos	8962	Rueda Simple 3304		4 Unidades
	8967	Rueda Simpl. Reg. c/Rul. (Max 50 Kg/Hoja)		
	8963	Rueda Dobl. Reg. c/Rul. (Max. 100Kg/Hoja)		
	9154	Rueda Dobl. Reg. c/Aguj. (Max. 150Kg/Hoja)		
	8130	Rueda Dobl. Reg. Optimus (160Kg/Hoja)		
Tope Central	9412	Tope Parante Central (T-118)		4 Unidades
Cruce de Hoja	9142	Cruce de Hoja		2 Unidades
Boca Desagüe	8946	Boca Desagüe T-94		s/m
Tapa Desagüe	8366	Tapa Desagüe T-69		2 Unidades
Tapón Hermetic.	9143	Tapón de Hermeticidad Caja de Agua		2 Unidades
Tapón (Opción con Tirador)	9708	Tapón Tirador Central, Perfil 518		2 Unidades

s/m: según medida.

Accesorios Contramarco: pág. 17 Premarco: pág. 17 y 18